

Complete gullies Easyflow, DN 50

Product information for the product group

ACO Product benefits

- Retrofit clamping flange
- Optimum cleaning option
- Adjustable height thin bed seal
- Retrofit fire protection

Fire protection

Fire resistance class R30 – R120 tested according AbZ: Z-19.17-1887

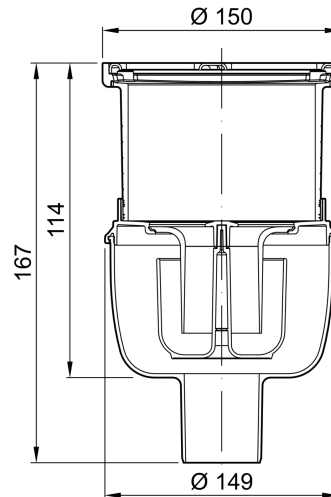



Item Technical Data 2500.55.77

Nominal width	Version	Side inlet	Recess [mm]	Flow rate [l/s]	Height-adjustability [mm]	Weight [kg]
DN 50	Standard	Without lateral inlet	200 x 200	1.5	15 – 96	0.9

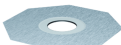
Accessories

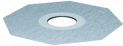
Description	Used with	Weight [kg]	PU [piece]	Item number
 <p>Extension</p> <ul style="list-style-type: none"> ■ Made of plastic ■ Suitable for taking plastic top sections and clamping flanges ■ With lip seal ■ For deeper installation of floor gullies 	<ul style="list-style-type: none"> ■ All Easyflow floor drains ■ Top sections <ul style="list-style-type: none"> □ Socket diameter 125 mm ■ Walk-in with gully sockets 	0.3		2040.00.00
 <p>Thin-bed flange</p> <ul style="list-style-type: none"> ■ Plastic flange with sprayed-on fleece ■ Suitable for taking liquid sealants added on-site using thin bed process 	<ul style="list-style-type: none"> ■ All Easyflow top sections <ul style="list-style-type: none"> □ 2500.77.11 □ 2700.77.11 □ 2700.77.12 ■ Top section with socket diameter 125 mm 	0.2		2040.00.01

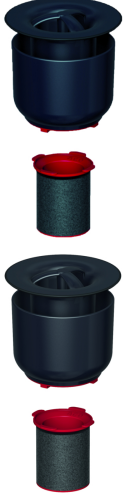
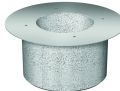
	Description	Used with	Weight [kg]	PU [piece]	Item number
	Thin-bed flange ■ Flange made of plastic with sprayed on non-woven material ■ Suitable for holding liquid seals applied on site using the thin bed method	■ All Easyflow top sections <input type="checkbox"/> 2500.77.11. <input type="checkbox"/> 2700.77.11 <input type="checkbox"/> 2700.77.12 ■ Top sections with socket diameter: 125 mm	0.2	4	679945
	Compressed seal flange ■ Plastic flange ■ Loose flange made from stainless steel ■ Suitable for taking sealants foils added on-site for sealing layers for point drainage	■ All Easyflow floor drains	0.6		2040.00.02
	Odour stop ■ Prevents unpleasant odours from the sewage system, irrespective of the water seal height	■ Floor gullies, Easyflow <input type="checkbox"/> Standard <input type="checkbox"/> DN 50	0.1		2000.00.06
	Fire protection set ■ Fire and smoke blocker for subsequent fire protection equipment of Easyflow gully bodies ■ Discharge value of the gully body reduces by 0.5 l/s in use ■ Water seal height 50 mm ■ Consisting of <input type="checkbox"/> Odour trap with heat shield <input type="checkbox"/> Fire protection cartridge ■ German approval <input type="checkbox"/> AbZ. Z-19.17-2159 <input type="checkbox"/> abG: Z-19.53-2442	■ Floor gullies, Easyflow <input type="checkbox"/> DN 50 <input type="checkbox"/> Socket inclination: 90°	0.2		2520.00.00
	Fit-in installation set ■ Non-combustible <input type="checkbox"/> Building material class A1 ■ For mortar-free installation in core drills: Ø 225 mm ■ Fit-in dimensions <input type="checkbox"/> Ø: 215 mm <input type="checkbox"/> Height: 139 mm ■ German approval <input type="checkbox"/> AbZ. Z-19.17-2159 <input type="checkbox"/> abG: Z-19.53-2442	■ Floor gullies, Easyflow <input type="checkbox"/> Socket inclination: 90°			
		DN 50	3.1		9390.08.40

You can find further accessories under → <https://www.buildingdrainage.aco/search/?q=2500.55.77>