

## Installation Instructions

### Radiator thermostat RA 2000, universal model

### Installation, temperature setting, limitation and blocking, theft protection

#### Installation

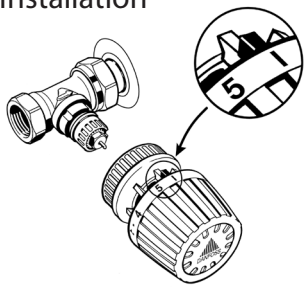

Remove the valve cover.  
Check that the thermostat is set at the factory setting of 5.

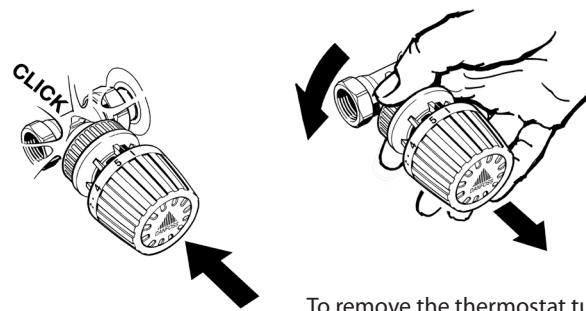

Push the thermostat firmly onto the valve until an audible "click" is heard.

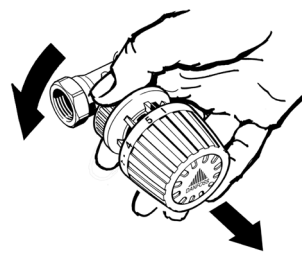

To remove the thermostat turn the base counter-clockwise. This will also reset the the snap-action mechanism when an audible "click" is heard.

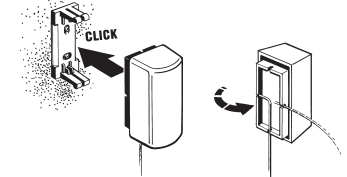

The remote sensor must not be in a drafty location or be covered. Do not install above a heat source. Attach the sensor bracket to the desired location. Pull out the required length of capillary tube and secure to the sensor as shown. Push the sensor onto the base.

#### Mounting thermostat with built-in sensor

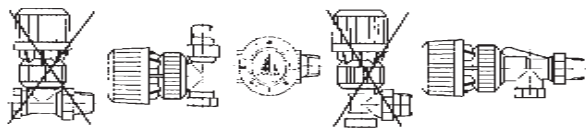

#### Mounting thermostat with remote sensor

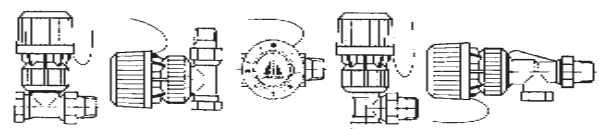

#### Temperature setting

45	49	57	63	68	73	79	82°F
79,5	14	17	20	23	26	28°C	
* 1 2 . . 3 . . 4 5							

\* = Frost protection setting

The required room temperature is obtained by turning the thermostat knob. The numbers on the dial correspond to the approximate temperatures of the scale. The temperatures indicated are

guidelines only. The actual room temperature will depend on structural factors affecting the thermostats, location, etc.

#### Limiting and blocking the setting range

##### Upper limit setting (max. setting)

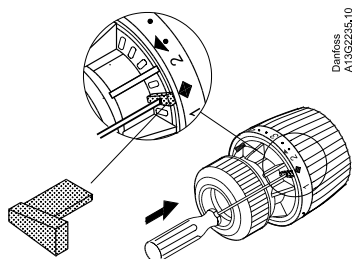

Example: Required max. value = "4"  
- Set thermostat at "4"  
- Remove a pin from the bottom of the thermostat with a screwdriver and mount it under the diamond mark on the knob (between setting positions 1 and 2).

##### Lower limit setting (min. setting)

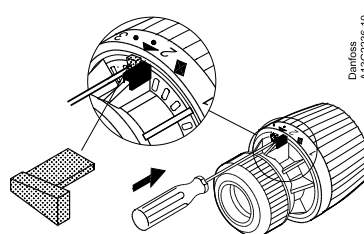

Example: Required min. value = "2"  
- Set thermostat at "2"  
- Remove a pin from the bottom of the thermostat with a screwdriver and mount it under the triangle mark on the knob (between setting positions 2 and 3).

##### Locking setting

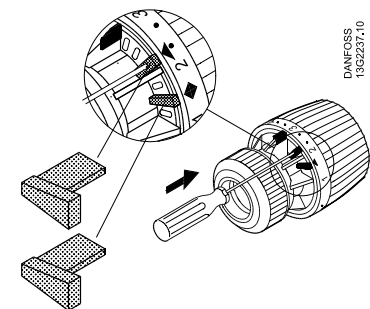

Example: Required locked value = "3"  
- Set thermostat at "3"  
- Remove both pins from the thermostat.  
- Place one pin under the diamond mark and the other pin under the triangle mark.

#### Theft protection

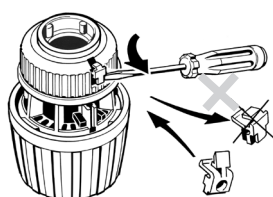

Remove the cover and install the theft protection button, code 013G5245 without pushing it all the way in.

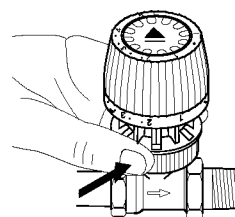

Once the thermostat is mounted on the valve, push in the theft protection device. The thermostat cannot be removed.

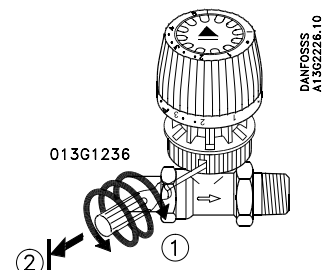

To remove the theft protection use screwdriver 013G1236 and screw into the hole (1). Pulled out until the stop is reached (2).

Radiator thermostat RA 2000, tamper-proof model  
 Installation, temperature setting, limiting and blocking, theft protection

Installation

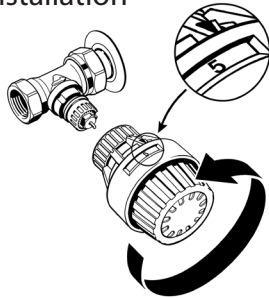

Remove the valve cover.  
 Check that the thermostat is set at the factory setting of 5.

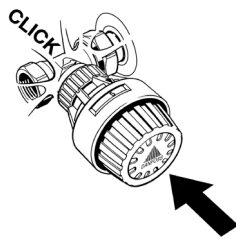

Push the thermostat firmly onto the valve until an audible "click" is heard.

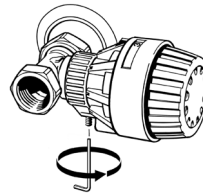

The clamping band can be rotated to one of four positions to allow easier access to the allen screw.  
 Loosen screw if required.

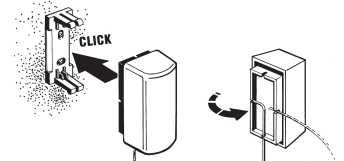

The remote sensor must not be in a drafty location or be covered. Do not install above a heat source. Attach the sensor bracket to the desired location. Pull out the required length of capillary tube and secure to the sensor as shown. Push the sensor onto the base.

Mounting thermostat with built-in sensor

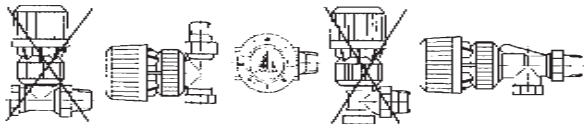

Mounting thermostat with remote sensor

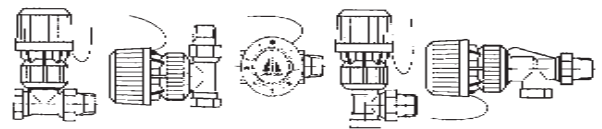

Temperature setting

45	49	57	63	68	73	79	82°F
79,5	14	17	20	23	26	28°C	
* 1 2 . . 3 . . 4 5							

\* = Frost protection setting

The required room temperature is obtained by turning the thermostat knob. The numbers on the dial correspond to the approximate temperatures of the scale. The temperatures indicated are

guidelines only. The actual room temperature will depend on structural factors affecting the thermostats, location, etc.

Limiting and blocking the setting range

Upper limit setting (max. setting)

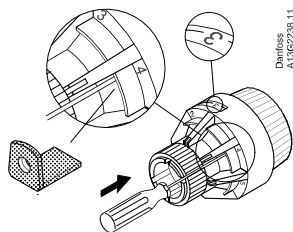

Example: Required max. value = "4"  
 - Set thermostat at a setting below "4".  
 - Remove a pin from the bottom of the thermostat with the threaded screwdriver and fit it at the position marked 4 on the back of the thermostat black cover.

Lower limit setting (min. setting)

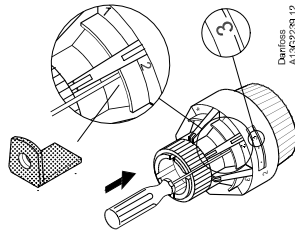

Example: Required min. value = "2"  
 - Set thermostat at a setting above "2".  
 - Remove a pin from the bottom of the thermostat with the threaded screwdriver and fit it at the position marked 2 on the back of the thermostat black cover.

Locking setting

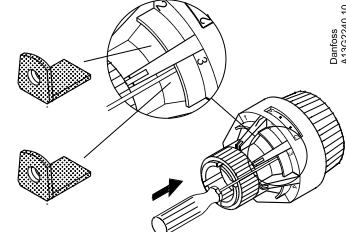

Example: Required locked value = "3"  
 - Set thermostat at a setting below "3".  
 - Place one pin opposite the 3 on the back.  
 - Turn the thermostat to setting "3".  
 - Place the second pin opposite the 2 on the back.

Theft protection

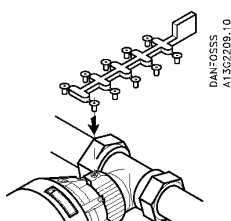

Push the theft protection device into the hexagonal hole of the allen screw.

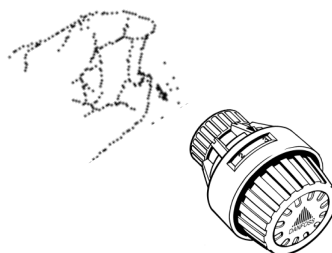

The setting window can be covered using scale covers that are available as an accessory.

Accessories

Theft protection devices (20pcs)	013G1232
Limit pins (10pcs)	013G1246
Range limiting pins	013G1237
Danfoss screwdriver set	013G1236
Threaded screwdriver	013G1231
Scale covers (20pcs)	013G1672