

<b>DE</b>	Gebrauchsanleitung / Montageanleitung	<b>2</b>
<b>FR</b>	Mode d'emploi / Instructions de montage	<b>3</b>
<b>EN</b>	Instructions for use / Assembly instructions	<b>4</b>
<b>IT</b>	Istruzioni per l'uso / Istruzioni per Installazione	<b>5</b>
<b>ES</b>	Modo de empleo / Instrucciones de montaje	<b>6</b>
<b>NL</b>	Gebruiksaanwijzing / Handleiding	<b>7</b>
<b>DK</b>	Brugsanvisning / Monteringsvejledning	<b>8</b>
<b>PT</b>	Instruções para uso / Manual de Instalação	<b>9</b>
<b>PL</b>	Instrukcja obsługi / Instrukcja montażu	<b>10</b>
<b>CS</b>	Návod k použití / Montážní návod	<b>11</b>
<b>SK</b>	Návod na použitie / Montážny návod	<b>12</b>
<b>ZH</b>	用户手册 / 组装说明	<b>13</b>
<b>RU</b>	Руководство пользователя / Инструкция по монтажу	<b>14</b>
<b>FI</b>	Käyttöohje / Asennusohje	<b>15</b>
<b>SV</b>	Bruksanvisning / Monteringsanvisning	<b>16</b>
<b>LT</b>	Vartotojo instrukcija / Montavimo instrukcijos	<b>17</b>
<b>HR</b>	Upute za uporabu / Uputstva za instalaciju	<b>18</b>
<b>TR</b>	Kullanım kılavuzu / Montaj kılavuzu	<b>19</b>
<b>RO</b>	Manual de utilizare / Instrucțiuni de montare	<b>20</b>
<b>EL</b>	Οδηγίες χρήσης / Οδηγία συναρμολόγησης	<b>21</b>
<b>SI</b>	Navodilo za uporabo / Navodila za montažo	<b>22</b>
<b>ET</b>	Kasutusjuhend / Paigaldusjuhend	<b>23</b>
<b>LV</b>	Lietošanas pamācība / Montāžas instrukcija	<b>24</b>
<b>SR</b>	Uputstvo za upotrebu / Uputstvo za montažu	<b>25</b>
<b>NO</b>	Bruksanvisning / Montasjeveiledning	<b>26</b>
<b>BG</b>	Инструкция за употреба / Ръководство за монтаж	<b>27</b>
<b>SQ</b>	Udhëzuesi i përdorimit / Udhëzime rreth montimit	<b>28</b>
<b>AR</b>	دليل الاستخدام / تعليمات التجميع	<b>29</b>
<b>HU</b>	Használati útmutató / Szerelési útmutató	<b>30</b>
<b>JP</b>	取扱説明書 / 施工説明書	<b>31</b>



**Metris 100**

31088000

31186000

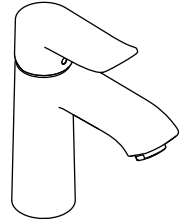

**Metris 110**

31080000

31084000

31203000

31204000

31045000

**Metris 110**

**CoolStart**

31121000

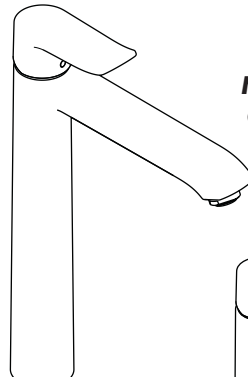

**Metris 260**

31082000

31184000

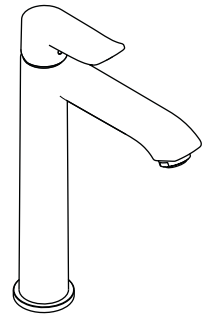

**Metris 200**

31183000

31185000

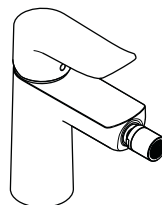

**Metris**

31280000



## Sicherheitshinweise

- ⚠ Bei der Montage müssen zur Vermeidung von Quetsch- und Schnittverletzungen Handschuhe getragen werden.
- ⚠ Das Produkt darf nur zu Bade-, Hygiene- und Körperreinigungszwecken eingesetzt werden.
- ⚠ Große Druckunterschiede zwischen den Kalt- und Warmwasseranschlüssen müssen ausgeglichen werden.

## Montagehinweise

- Vor der Montage muss das Produkt auf Transportschäden untersucht werden. Nach dem Einbau werden keine Transport- oder Oberflächenschäden anerkannt.
- Die Leitungen und die Armatur müssen nach den gültigen Normen montiert, gespült und geprüft werden.
- Die in den Ländern jeweils gültigen Installationsrichtlinien sind einzuhalten.
- Das Ablaufventil darf nur zum bestimmungsgemäßen Gebrauch verwendet werden. Das Befestigen von anderen Gegenständen z. B. einer Halbsäule an dem Ablaufventil ist nicht zulässig.
- Bei Problemen mit dem Durchlauferhitzer oder wenn mehr Wasserdurchsatz gewünscht wird, kann der EcoSmart® (Durchflussbegrenzer), der hinter dem Luftsprudler sitzt, entfernt werden.

## Technische Daten

### Armatur serienmäßig mit EcoSmart® (Durchflussbegrenzer)

Betriebsdruck:	max. 1 MPa
Empfohlener Betriebsdruck:	0,1 - 0,5 MPa
Prüfdruck:	1,6 MPa
	(1 MPa = 10 bar = 147 PSI)
Heißwassertemperatur:	max. 70 °C
Empfohlene Heißwassertemperatur:	65 °C
Thermische Desinfektion:	max. 70 °C / 4 min

Das Produkt ist ausschließlich für Trinkwasser konzipiert!

## Symbolerklärung



Kein essigsäurehaltiges Silikon verwenden!



### Justierung (siehe Seite 32)

Einstellen der Warmwasserbegrenzung. In Verbindung mit Durchlauferhitzern ist eine Warmwassersperre nicht zu empfehlen.



### Maße (siehe Seite 36)



### Durchflussdiagramm (siehe Seite 36)

- ① mit EcoSmart®
- ② ohne EcoSmart®



### Serviceteile (siehe Seite 38)

## Sonderzubehör

(nicht im Lieferumfang enthalten)



- Montageschlüssel #58085000 (siehe Seite 33)



- Installationskitt (siehe Seite 33)



### Reinigung (siehe Seite 40)



### Bedienung (siehe Seite 35)

- Hansgrohe empfiehlt, morgens oder nach längeren Stagnationszeiten den ersten halben Liter nicht als Trinkwasser zu verwenden.
- Um eine Stagnation in den Anschlussleitungen zu vermeiden, muss nach längeren Gebrauchspausen, mindestens aber jeden dritten Tag, die Armatur in Griffstellung heiß und kalt geöffnet werden bis eine gleichbleibende Auslauftemperatur erreicht ist.



### Prüfzeichen (siehe Seite 35)



## Consignes de sécurité

- △ Lors du montage, porter des gants de protection pour éviter toute blessure par écrasement ou coupure.
- △ Le produit ne doit servir qu'à se laver et à assurer l'hygiène corporelle.
- △ Il est conseillé d'équilibrer les pressions de l'eau chaude et froide.

## Instructions pour le montage

- Avant son montage, s'assurer que le produit n'a subi aucun dommage pendant le transport. Après le montage, tout dommage de transport ou de surface ne pourra pas être reconnu.
- Les conduites et la robinetterie doivent être montés, rincés et contrôlés selon les normes en vigueur.
- Les directives d'installation en vigueur dans le pays concerné doivent être respectées.
- La vanne d'écoulement ne doit être utilisée qu'aux fins auxquelles elle a été conçue. La fixation d'autres objets, tels p. ex. qu'une demi-colonne, est interdite sur la vanne d'écoulement.
- En cas de problèmes avec le chauffe-eau, ou bien si le débit d'eau doit être plus important, il est possible d'enlever l'EcoSmart® (limiteur de débit) se trouvant derrière l'aérateur.

## Informations techniques

### Robinetterie équipée en série d'un EcoSmart® (limiteur de débit)

Pression de service autorisée: max. 1 MPa  
 Pression de service conseillée: 0,1 - 0,5 MPa  
 Pression maximum de contrôle: 1,6 MPa  
 (1 MPa = 10 bar = 147 PSI)

Température d'eau chaude: max. 70 °C  
 Température recommandée: 65 °C  
 Désinfection thermique: max. 70 °C / 4 min

Le produit est exclusivement conçu pour de l'eau potable!

## Description du symbole



Ne pas utiliser de silicone contenant de l'acide acétique!



## Étalonnage (voir pages 32)

Réglage de la limitation d'eau chaude. En liaison avec les chauffe-eau, un blocage de l'eau chaude n'est pas recommandable.



## Dimensions (voir pages 36)



## Diagramme du débit (voir pages 36)

- ① avec EcoSmart®
- ② sans EcoSmart®



## Pièces détachées (voir pages 38)

## Accessoires en option

(ne fait pas partie de la fourniture)



- clé de montage #58085000 (voir pages 33)



- Mastic d'installation (voir pages 33)



## Nettoyage (voir pages 40)



## Instructions de service

(voir pages 35)

- Hansgrohe recommande de ne pas utiliser le premier demi-litre le matin ou après une période de stagnation prolongée.
- Afin d'éviter une stagnation dans les conduites de raccordement après une inutilisation prolongée, il faut ouvrir au moins une fois tous les 3 jours le robinet en position chaud et froid, jusqu'à l'obtention d'une température de sortie uniforme.



## Classification acoustique et débit

(voir pages 35)



## Safety Notes

- ⚠ Gloves should be worn during installation to prevent crushing and cutting injuries.
- ⚠ The product may only be used for bathing, hygienic and body cleaning purposes.
- ⚠ The hot and cold supplies must be of equal pressures.

## Installation Instructions

- Prior to installation, inspect the product for transport damages. After it has been installed, no transport or surface damage will be honoured.
- The pipes and the fixture must be installed, flushed and tested as per the applicable standards.
- The plumbing codes applicable in the respective countries must be observed.
- The drain valve must only be used as intended. It is not allowed to attach other objects to the drain valve, for example a semi-pedestal.
- If the instantaneous water heater causes problems or if you wish to increase the water flow, the EcoSmart® (flow limiter) located behind the aerator can be removed.

## Technical Data

### This mixer series-produced with EcoSmart® (flow limiter)

Operating pressure: max. 1 MPa  
 Recommended operating pressure: 0,1 - 0,5 MPa  
 Test pressure: 1,6 MPa

(1 MPa = 10 bar = 147 PSI)

Hot water temperature: max. 70°C

Recommended hot water temp.: 65°C

Thermal disinfection: max. 70°C / 4 min

The product is exclusively designed for drinking water!

## Symbol description



Do not use silicone containing acetic acid!



## Adjustment (see page 32)

To adjust the hot water limiter. Using a hot water limiter in combination with a continuous flow water heater is not recommended.



## Dimensions (see page 36)



## Flow diagram (see page 36)

- ① with EcoSmart®
- ② without EcoSmart®



## Spare parts (see page 38)

## Special accessories (order as an extra)



- special tool #58085000 (see page 33)



- Installation putty (see page 33)



## Cleaning (see page 40)



## Operation (see page 35)

- Hansgrohe recommends not to use as drinking water the first half liter of water drawn in the morning or after a prolonged period of non-use.
- After periods of prolonged non-use, but at least every third day, the fittings must be opened with the handle in hot and cold position to prevent stagnation in the connecting lines. Let the water run until the water temperature is constant.



## Test certificate (see page 35)





## **Indicazioni sulla sicurezza**

- △ Durante il montaggio, per evitare ferite da schiacciamento e da taglio bisogna indossare guanti protettivi.
- △ Il prodotto deve essere utilizzato esclusivamente per fare il bagno e per l'igiene del corpo.
- △ Attenzione! Compensare le differenze di pressione tra i collegamenti dell'acqua fredda e dell'acqua calda.

## **Istruzioni per il montaggio**

- Prima del montaggio è necessario controllare che non ci siano stati danni durante il trasporto. Una volta eseguito il montaggio, non verranno riconosciuti eventuali danni di trasporto o delle superfici.
- Montare, lavare e controllare tubature e rubinetteria rispettando le norme correnti.
- Vanno rispettate le direttive di installazione nazionali vigenti nel rispettivo paese.
- Utilizzare la valvola di scarico solo conforme alla destinazione. Non è consentito fissare altri oggetti, ad es. una semi-colonna, alla valvola di scarico.
- Nel caso di problemi con lo scalda-acqua oppure nel caso si desiderasse più erogazione, si può eliminare il EcoSmart® (limitatore di flusso) che si trova dietro la valvola di aerazione.

## **Dati tecnici**

### **Questo miscelatore è dotato di serie del EcoSmart® (limitatore di flusso)**

Pressione d'uso:	max. 1 MPa
Pressione d'uso consigliata:	0,1 - 0,5 MPa
Pressione di prova:	1,6 MPa
	(1 MPa = 10 bar = 147 PSI)
Temperatura dell'acqua calda:	max. 70 °C
Temp. dell'acqua calda consigliata:	65 °C
Disinfezione termica:	max. 70 °C / 4 min

Il prodotto è concepito esclusivamente per acqua potabile!

## **Descrizione simbolo**



Non utilizzare silicone contenente acido acetico!



## **Taratura (vedi pagg. 32)**

Regolazione del limitatore di erogazione d'acqua calda. Un limitatore di erogazione di acqua calda in combinazione con le caldaie istantanee non è consigliabile.



## **Ingombri (vedi pagg. 36)**

## **Diagramma flusso (vedi pagg. 36)**

- ① con EcoSmart®
- ② senza EcoSmart®



## **Parti di ricambio (vedi pagg. 38)**

## **Accessori speciali**

(non contenuto nel volume di fornitura)



- chiave per montaggio #58085000 (vedi pagg. 33)



- Mastice d'installazione (vedi pagg. 33)



## **Pulitura (vedi pagg. 40)**



## **Procedura (vedi pagg. 35)**

- Hansgrohe raccomanda, di mattina oppure dopo lunghi tempi di stagnazione, di non utilizzare il primo mezzo litro come acqua potabile.
- Per evitare un ristagno nelle condotte di allacciamento, dopo lunghe pause senza utilizzo, almeno però ogni terzo giorno, bisogna aprire il valvolame nella posizione calda e fredda fino a quando si è raggiunto una temperatura d'uscita uniforme.



## **Segno di verifica (vedi pagg. 35)**



## Indicaciones de seguridad

- △ Durante el montaje deben utilizarse guantes para evitar heridas por aplastamiento o corte.
- △ El producto solo debe ser utilizado para fines de baño, higiene y limpieza corporal.
- △ Grandes diferencias de presión en servicio entre agua fría y agua caliente deben equilibrarse.

## Indicaciones para el montaje

- Antes del montaje se debe examinar el producto contra daños de transporte. Después de la instalación no se reconoce ningún daño de transporte o de superficie.
- Los conductos y la grifería deben montarse, lavarse y comprobarse según las normas vigentes.
- Es obligatorio el cumplimiento de las directrices de instalación vigentes en el país respectivo.
- La válvula de desagüe solo puede ser utilizada para el uso especificado. No se permite fijar a la válvula de desagüe otros objetos, como una semicolumna.
- En caso de problemas con el calentador instantáneo o cuando se desee más caudal de agua puede quitarse el EcoSmart® (limitador de caudal), situado detrás del aireador.

## Datos técnicos

### Grifo, desde fábrica equipado con EcoSmart® (limitador de caudal)

Presión en servicio:	max. 1 MPa
Presión recomendada en servicio:	0,1 - 0,5 MPa
Presión de prueba:	1,6 MPa
	(1 MPa = 10 bar = 147 PSI)

Temperatura del agua caliente: max. 70 °C

Temp. recomendada del agua caliente: 65 °C

Desinfección térmica: max. 70 °C / 4 min

El producto ha sido concebido exclusivamente para agua potable.

## Descripción de símbolos



No utilizar silicona que contiene ácido acético!



### Ajuste (ver página 32)

Ajuste del límite de agua caliente. En combinación con calentadores continuos no es recomendable utilizar un bloqueo de agua caliente.



### Dimensiones (ver página 36)



### Diagrama de circulación

(ver página 36)

- ① con EcoSmart®
- ② sin EcoSmart®



### Repuestos (ver página 38)

### Opcional (no incluido en el suministro)



- Llave de montaje #58085000 (ver página 33)



- Masilla (ver página 33)



### Limpiar (ver página 40)



### Manejo (ver página 35)

- Hansgrohe recomienda no utilizar el primer medio litro como agua potable por las mañanas o tras un largo periodo de inactividad.
- Para evitar un estancamiento en las tuberías de conexión, tras una inactividad prolongada, pero al menos cada tres días, hay que abrir el grifo en la posición de caliente y frío hasta obtener una temperatura de salida constante.



### Marca de verificación

(ver página 35)





## Veiligheidsinstructies

- ⚠ Bij de montage moeten ter voorkoming van knel- en snijwonden handschoenen worden gedragen.
- ⚠ Het product mag alleen voor het wassen, hygiënische doeleinden en voor de lichaamreiniging worden gebruikt.
- ⚠ Grote drukverschillen tussen de koud- en warmwater-toevoer dienen vermeden te worden.

## Montage-instructies

- Vóór de montage moet het product gecontroleerd worden op transportschade. Na de inbouw wordt geen transport- of oppervlakteschade meer aanvaard.
- De leidingen en armaturen moeten gemonteerd, gespoeld en gecontroleerd worden volgens de geldige normen.
- De in de overeenkomstige landen geldende installatierichtlijnen moeten nageleefd worden.
- De uitlaatklep mag enkel gebruikt worden voor het reglementaire gebruik. Het bevestigen van andere voorwerpen, bv. een halfzuil op de uitlaatklep is niet toegestaan.
- Wanneer problemen optreden bij doorloopgeisers of wanneer een grotere waterdoorvoer gewenst is, kan de EcoSmart® (doorstroombegrenzer) die achter de perlator is gemonteerd, makkelijk verwijderd worden.

## Technische gegevens

### Armatuur standaard met EcoSmart® (doorstroombegrenzer)

Werkdruk: max.	max. 1 MPa
Aanbevolen werkdruk:	0,1 - 0,5 MPa
Getest bij:	1,6 MPa
	(1 MPa = 10 bar = 147 PSI)
Temperatuur warm water:	max. 70 °C
Aanbevolen warm water temp.:	65 °C
Thermische desinfectie:	max. 70 °C / 4 min

Het product is uitsluitend ontworpen voor drinkwater!

## Symboolbeschrijving

 Gebruik geen zuurhoudende silicone!

 **Instellen** (zie blz. 32)

Instellen van de warmwaterbegrenzing. In combinatie met een doorstromer is een warmwaterblokkering niet aanbevelenswaardig.

 **Maten** (zie blz. 36)



 **Doorstroomdiagram** (zie blz. 36)

- ① met EcoSmart®
- ② zonder EcoSmart®

 **Service onderdelen** (zie blz. 38)

## Toebehoren

(behoort niet tot het leveringspakket)

-  • montagesleutel #58085000 (zie blz. 33)
-  • Kit (zie blz. 33)

 **Reinigen** (zie blz. 40)

 **Bediening** (zie blz. 35)

- Hansgrohe raadt aan om 's morgens na langere stagnatietijden de eerste halve liter niet als drinkwater te gebruiken.
- Om stagnatie in de aansluitleidingen te vermijden, moet de armatuur na langere bedrijfsonderbrekingen en minstens alle drie dagen in de hete en koude stand geopend worden tot een constante uitlooptemperatuur bereikt is.

 **Keurmerk** (zie blz. 35)



## Sikkerhedsanvisninger

- △ Ved monteringen skal der bruges handsker for at undgå kvæstelser og snitsår.
- △ Produktet må kun bruges til bade-, hygiejne og kropsprengøringsformål.
- △ Større trykforskel mellem koldt og varmt vand bør udjævnes.

## Monteringsanvisninger

- Før monteringen skal produktet kontrolleres for transportskader. Efter monteringen godkendes transportskader eller skader på overfladen ikke længere.
- Ledningerne og armaturerne skal monteres, skylles og kontrolleres iht. de gældende standarder.
- Installationsbestemmelserne, der gælder i det enkelte land, skal overholdes.
- Afløbsventilen må kun bruges til det fastlagte formål. Det er ikke tilladt at fastgøre andre genstande f.eks. en halvsnøje til afløbsventilen.
- Ved problemer med gennemløbsvandvarmer eller hvis der ønskes mere vandgennemstrømning, kan EcoSmart® (gennemstrømningsbegrænseren), der sidder i perlatoren, fjernes.

## Tekniske data

### Armaturet er forsynet med EcoSmart® (gennemstrømningsbegrænsere)

Driftstryk:	max. 1 MPa
Anbefalet driftstryk:	0,1 - 0,5 MPa
Prøvetryk:	1,6 MPa
	(1 MPa = 10 bar = 147 PSI)
Varmtvandstemperatur:	max. 70 °C
Anbefalet varmtvandstemperatur:	65 °C
Termisk desinfektion:	max. 70 °C / 4 min

Produktet er udelukkende beregnet til drikkevand!

## Symbolbeskrivelse



Der må ikke benyttes eddikesyreholdig silikone!



### Forindstilling (se s. 32)

Indstilling af varmvandsbegrænsningen. I forbindelse med gennemstrømningsvandvarmere anbefaler vi ikke en varmvandsspærre.



### Målene (se s. 36)



## Gennemstrømningsdiagram

(se s. 36)

- ① med EcoSmart®
- ② uden EcoSmart®



## Reserve dele (se s. 38)



- Monteringsnøgle #58085000 (se s. 33)



- Kitt (se s. 33)



## Rengøring (se s. 40)



## Brugsanvisning (se s. 35)

- Hansgrohe anbefaler at den første halve liter om morgenen eller efter længere stagneringstider ikke anvendes som drikkevand.
- For at undgå en stagnation i tilslutningsledningerne, skal armaturet i stilling varm og koldt åbnes efter længere brugspauser dog mindst hver tredje dag indtil der opnås en uforudret udløbstemperatur.



## Godkendelse (se s. 35)





## Avisos de segurança

- △ Durante a montagem devem ser utilizadas luvas de protecção, de modo a evitar ferimentos resultantes de entalamentos e de cortes.
- △ O produto só pode ser utilizado para fins de higiene pessoal.
- △ Grandes diferenças entre as pressões das águas quente e fria devem ser compensadas.

## Avisos de montagem

- Antes da montagem deve-se controlar o produto relativamente a danos de transporte. Após a montagem não são aceites quaisquer danos de transporte ou de superfície.
- As tubagens e a torneira têm que ser montadas, enxaguadas e verificadas de acordo com as normas em vigor.
- A prescrições de instalação válidas nos respetivos países devem ser respeitadas.
- A válvula de escoamento só pode ser utilizada para o fim para o qual foi concebida. Não é permitida a fixação de outros objetos na válvula de escoamento como, por exemplo, uma semicolumna.
- Em caso de problemas com o esquentador de água ou se desejar maior débito de água, é possível retirar o EcoSmart® (limitador de caudal), situado por trás do emulsor.

## Dados Técnicos

### Misturadoras produzidas em série com EcoSmart® (limitador de caudal)

Pressão de funcionamento: max. 1 MPa  
 Pressão de func. recomendada: 0,1 - 0,5 MPa  
 Pressão testada: 1,6 MPa  
 (1 MPa = 10 bar = 147 PSI)

Temperatura da água quente: max. 70 °C  
 Temp. água quente recomendada: 65 °C  
 Desinfecção térmica: max. 70 °C / 4 min

Este produto foi única e exclusivamente concebido para água potável!

## Descrição do símbolo



Não utilizar silicone que contenha ácido acético!



## Afinação (ver página 32)

Ajuste do limitador de água quente. Em combinação com um esquentador, não é recomendável o uso de um bloqueio de água quente.



## Medidas (ver página 36)

### Fluxograma (ver página 36)

- ① com EcoSmart®
- ② sem EcoSmart®



## Peças de substituição (ver página 38)

## Acessórios especiais

(não incluído no volume de fornecimento)



- Chave especial #58085000 (ver página 33)



- Mástique (ver página 33)



## Limpeza (ver página 40)



## Funcionamento (ver página 35)

- A Hansgrohe recomenda a não utilização do primeiro meio litro de água, de manhã ou após longas paragens, para fins de consumo.
- De modo a evitar uma estagnação nas tubagens de conexão, é necessário abrir a torneira na posição da água quente e fria (pelo menos todos os três dias ou após longas interrupções de utilização) até se verificar uma temperatura de saída uniforme.



## Marca de controlo (ver página 35)



## Wskazówki bezpieczeństwa

- △ Aby uniknąć zranień na skutek zgniecenia lub przecięcia, podczas montażu należy nosić rękawice ochronne.
- △ Produkt może być używany tylko do kąpieli, higieny i czyszczenia ciała.
- △ Znaczne różnice ciśnień na dopływach ciepłej i zimnej wody muszą zostać wyrównane.

## Wskazówki montażowe

- Przed montażem należy skontrolować produkt pod kątem szkód transportowych. Po montażu nie widać żadnych szkód transportowych ani szkód na powierzchni.
- Przewody i armatura muszą być montowane, płukane i kontrolowane według obowiązujących norm.
- Należy przestrzegać wytycznych instalacyjnych obowiązujących w danym kraju.
- Zawór odpływowy można używać tylko zgodnie z przeznaczeniem. Mocowanie innych przedmiotów, np. półkolumny przy zaworze odpływowym, jest niedozwolone.
- W przypadku problemów z przepływowymi podgrzewaczami wody lub jeśli chce się uzyskać większy przepływ wody, można usunąć EcoSmart® (ogranicznik przepływu) znajdujący się za napowietrzaczem.

## Dane techniczne

### Armatura produkowana seryjnie z funkcją EcoSmart® (ogranicznik przepływu)

Ciśnienie robocze:	maks. 1 MPa
Zalecane ciśnienie robocze:	0,1 - 0,5 MPa
Ciśnienie próbne:	1,6 MPa
	(1 MPa = 10 bary = 147 PSI)
Temperatura wody gorącej:	maks. 70 °C
Zalecana temperatura wody gorącej:	65 °C
Dezynfekcja termiczna:	maks. 70 °C / 4 min

Produkt przeznaczony wyłącznie do wody pitnej!

## Opis symbolu



Nie stosować silikonów zawierających kwas octowy!



## Ustawianie (patrz strona 32)

Ustawianie ogranicznika ciepłej wody. Używanie ogranicznika temperatury wody w połączeniu z przepływowym podgrzewaczem wody nie jest zalecane.



## Wymiary (patrz strona 36)

### Schemat przepływu (patrz strona 36)

- ① z EcoSmart®
- ② bez EcoSmart®



## Części serwisowe (patrz strona 38)

## Wyposażenie specjalne

(Nie jest częścią dostawy)



- Klucz montażowy #58085000 (patrz strona 33)



- Kit instalatorski (patrz strona 33)



## Czyszczenie (patrz strona 40)



## Obsługa (patrz strona 35)

- Hansgrohe zaleca, by z rana lub po dłuższym czasie niekorzystania, pierwsze pół litra wody nie używać jako wody pitnej.
- W celu uniknięcia stagnacji w przewodach doprowadzających, po dłuższych przerwach w użytkowaniu, przynajmniej jednak co trzy dni, należy otworzyć armaturę w pozycji wody gorącej i zimnej, aby osiągnąć temperaturę na wylocie na stałym poziomie.



## Znak jakości (patrz strona 35)



## **Bezpečnostní pokyny**

- ⚠ Pro zabránění řezným zraněním a pohmožděninám je nutné při montáži nosit rukavice.
- ⚠ Produkt smí být používán pouze ke koupání a za účelem tělesné hygieny.
- ⚠ Je nutné vyrovnat velké rozdíly tlaku mezi přípoji studené a teplé vody.

## **Pokyny k montáži**

- Před montáží je třeba produkt zkontrolovat, zda nebyl při transportu poškozen. Po zabudování nebudou uznány žádné škody způsobené transportem nebo poškození povrchu.
- Vedení a armatura musí být namontovány, propláchnuty a otestovány podle platných norem.
- Je třeba dodržovat montážní pravidla platné v dané zemi.
- Vypouštěcí ventil je povoleno používat pouze dle určení. Připevňování jiných předmětů např. polosloupu k vypouštěcímu ventilu není přípustné.
- Při problémech s průtokovým ohřívačem, nebo když je požadován větší průtok, může být odstraněno zařízení EcoSmart® (omezovač průtoku), které je umístěno za perlátorem.

## **Technické údaje**

### **Armatura je sériově vybavena zařízením EcoSmart® (omezovač průtoku)**

Provozní tlak:	max. 1 MPa
Doporučený provozní tlak:	0,1 - 0,5 MPa
Zkušební tlak:	1,6 MPa
	(1 MPa = 10 bar = 147 PSI)

Teplota horké vody: max. 70 °C

Doporučená teplota horké vody: 65 °C

Teplná desinfekce: max. 70 °C / 4 min

Výrobky Hansgrohe jsou vhodné pro přímý kontakt s pitnou vodou.

## **Popis symbolů**



Nepoužívat silikon s obsahem kyseliny octové!



### **Nastavení** (viz strana 32)

Nastavení omezovače teplé vody. Ve spojení s průtokovým ohřívačem se použití uzávěru teplé vody nedoporučuje.



### **Rozměry** (viz strana 36)



### **Diagram průtoku** (viz strana 36)

- ① se zařízením EcoSmart®
- ② bez zařízení EcoSmart®



### **Servisní díly** (viz strana 38)

## **Zvláštní příslušenství** (není součástí dodávky)



- montážní klíč #58085000 (viz strana 33)



- Instalační kit (viz strana 33)



### **Čištění** (viz strana 40)



### **Ovládání** (viz strana 35)

- Hansgrohe doporučuje ráno nebo po delších přestávkách nepoužívat prvního půl litru jako pitnou vodu.
- Pokud chcete zabránit stagnaci v přípojných vedeních, musíte po delších přestávkách, alespoň však každý třetí den, otevřít armaturu v poloze horká a studená, dokud není výstupní teplota konstantní.



### **Zkušební značka** (viz strana 35)



## **Bezpečnostné pokyny**

- △ Pri montáži musíte nosiť rukavice, aby ste predišli pomliaždeninám a rezným poraneniam.
- △ Produkt sa smie používať len na kúpanie a telesnú hygienu.
- △ Veľké rozdiely v tlaku medzi prípojkami studenej a teplej vody musia byť vyrovnané.

## **Pokyny pre montáž**

- Pred montážou musíte produkt skontrolovať, či nebol počas transportu poškodený. Po zabudovaní nebudú uznané žiadne škody spôsobené transportom alebo poškodenia povrchu.
- Potrubia a vybavenie musia byť namontované, prepláchnuté a vybavené v platnom normami.
- Je potrebné dodržiavať smernice o inštalácii, ktoré sú práve teraz platné v krajinách.
- Odtokový ventil sa smie používať iba na použitie v súlade s určením. Upevňovanie iných predmetov, napr. polovičného sípku na odtokový ventil, nie je prípustné.
- Pri problémoch s prietokovým ohrievačom alebo ak je požadovaný väčší prietok vody, môže sa demontovať zariadenie EcoSmart® (obmedzovač prietoku), ktoré je umiestnené za perlátorom.

## **Technické údaje**

### **Armatúra je sériovo vybavená zariadením EcoSmart® (obmedzovač prietoku)**

Prevádzkový tlak: max. 1 MPa  
 Doporučený prevádzkový tlak: 0,1 - 0,5 MPa  
 Skúšobný tlak: 1,6 MPa  
 (1 MPa = 10 bar = 147 PSI)

Teplota teplej vody: max. 70 °C  
 Doporučená teplota teplej vody: 65 °C  
 Termická dezinfekcia: max. 70 °C / 4 min

Výrobok je koncipovaný výhradne pre pitnú vodu!

## **Popis symbolov**



Nepoužívať silikón s obsahom kyseliny octovej!



### **Nastavenie** (vid' strana 32)

Nastavenie obmedzenia teplej vody. V spojení s prietokovými ohrievačmi sa neodporúča použitie obmedzovača teplej vody.



### **Rozmery** (vid' strana 36)



### **Diagram prietoku** (vid' strana 36)

- ① so zariadením EcoSmart®
- ② bez zariadenia EcoSmart®



### **Servisné diely** (vid' strana 38)

## **Zvláštne príslušenstvo**

(nie je súčasťou dodávky)



- montážny kľúč #58085000 (vid' strana 33)



- Inštalačná súprava (vid' strana 33)



### **Čistenie** (vid' strana 40)



### **Obsluha** (vid' strana 35)

- Hansgrohe odporúča ráno a po dlhších dobách odstávky nepoužiť prvého pol litra vody ako pitnú vodu.
- Aby sa zabránilo stagnácii v prípojných vedeniach, musí sa po dlhších prestávkach medzi používaním, minimálne však každý tretí deň, otvoriť armatúra v polohe páky horúca a studená, kým sa nedosiahne konštantná výstupná teplota.



### **Osvedčenie o skúške** (vid' strana 35)



## 安全技巧

- △ 装配时为避免挤压和切割受伤，必须戴上手套。
- △ 本产品只允许作为洗浴、卫生和洁身之用。
- △ 冷热水管间过大的压力差必须予以平衡。

## 安装提示

- 安装前必须检查产品是否受到运输损害。安装后将不认可运输损害或表面损伤。
- 管道和阀门必须根据通用标准进行安装、冲洗和检查。
- 请遵守当地国家现行的安装规定。
- 只能按规定使用溢流阀。禁止将半露柱及其他部件固定到溢流阀上。
- 如果使用即热式热水器时出现问题，或要求更大的水流量，可以把位于水波器后面的 EcoSmart® (流量限制器) 拆除。

## 技术参数

本龙头配有 **EcoSmart®** (流量限制器)

工作压强:	最大 1 MPa
推荐工作压强:	0,1 - 0,5 MPa
测试压强:	1,6 MPa

(1 MPa = 10 bar = 147 PSI)

热水温度:	最大 70°C
推荐热水温度:	65°C
热力消毒:	最大 70°C / 4 分钟

该产品专为饮用水设计！

## 符号说明



请勿使用含有乙酸的硅胶！



调节 (参见第页 32)

热水温度调节。如果使用即热式喷头，则不建议安装热水阀门。



大小 (参见第页 36)



流量示意图 (参见第页 36)

- ① 带有 EcoSmart®
- ② 无 EcoSmart®



备用零件 (参见第页 38)

## 选装附件 (不在供货范围内)



• 专用工具 #58085000 (参见第页 33)



• 水管胶泥 (参见第页 33)



清洗 (参见第页 40)



操作 (参见第页 35)

- 汉斯格雅建议，清晨或在水流长时间停滞后，前半升水不作饮用水使用。
- 为了避免在连接管路内发生堵塞，如长时间未使用，则必须至少每三天将龙头调至热水和冷水位置，并打开龙头，直至水流温度保持恒定。



检验标记 (参见第页 35)



## Указания по технике безопасности

- △ Во время монтажа следует надеть перчатки во избежание прищемления и порезов.
- △ Изделие разрешается использовать только в гигиенических целях: для принятия ванны и личной гигиены.
- △ донного клапа. Перед установкой смесителя необходимо регулировочными кранами выровнять авление холодной и горячей воды при помощи вентмлей регулирующих подачу воды в квартиру.

## Указания по монтажу

- Перед монтажом следует проверить изделие на предмет повреждений при перевозке. После монтажа претензии о возмещении ущерба за повреждения при перевозке или повреждения поверхностей не принимаются.
- Трубы и арматура должны быть установлены, промыты и проверены в соответствии с действующими нормами.
- Необходимо соблюдать требования по монтажу, действующие в соответствующих странах.
- Спускной клапан разрешается использовать только в предусмотренных целях. На спускном клапане запрещается закреплять другие предметы, например, полуколонну.
- Если возникнут проблемы с проточным бойлером или потребуется увеличить расход воды, то можно удалить EcoSmart® (ограничитель потока воды), который установлен за воздушным рассекателем.

## Технические данные

### Смесители этой серии серийно оснащаются EcoSmart® (ограничителем потока воды)

Рабочее давление: не более. 1 МПа

Рекомендуемое рабочее давление: 0,1 - 0,5 МПа

Давлении: 1,6 МПа

(1 МПа = 10 bar = 147 PSI)

Температура горячей воды: не более. 70 °С

Рекомендуемая темп. гор. воды: 65 °С

Термическая дезинфекция: не более. 70 °С / 4 мин

Изделие предназначено исключительно для питьевой воды!

## Описание символов



Не применяйте силикон, содержащий уксусную кислоту.



## Подгонка (см. стр. 32)

Регулировка ограничителя горячей воды. В сочетании с проточными нагревателями не рекомендуется использовать блокировку воды.



## Размеры (см. стр. 36)



## Схема потока (см. стр. 36)

- ① С EcoSmart®
- ② Без EcoSmart®



## Комплект (см. стр. 38)

## Специальные принадлежности

(не включено в объем поставки!)



• Монтажный ключ #58085000 (см. стр. 33)



• Монтаж подводки (см. стр. 33)



## Очистка (см. стр. 40)



## Эксплуатация (см. стр. 35)

- Hansgrohe рекомендует по утрам либо после длительного перерыва в использовании не использовать первые поллитра воды для питья.
- Во избежание стагнации в подсоединительных проводах после длительных пауз в использовании, минимум раз в три дня, арматуру нужно открывать в горячем и холодном положении ручки, пока не будет достигнута равномерная температура выходящей воды.



## Знак технического контроля

(см. стр. 35)



## Turvallisuusohjeet

- △ Asennuksessa on käytettävä käsiineitä puristumien ja viillojen aiheuttamien tapaturmien estämiseksi.
- △ Tuotetta saa käyttää ainoastaan kylpy-, hygienia- ja puhdistustarkoituksiin.
- △ Suuret paine-erot kylmä- ja kuumavesiliitäntöjen välillä on tasattava.

## Asennusohjeet

- Ennen asennusta on tarkastettava tuotteen mahdolliset kuljetusvahingot. Asennuksen jälkeen kuljetus- ja pintavaurioita ei hyväksytä.
- Putket ja hana on asennettava, huuhdeltava ja tarkastettava voimassa olevien standardien mukaisesti.
- Jokaisessa maassa on noudatettava siellä päteviä asennusohjeita.
- Poistoventtiiliä saa käyttää vain tarkoituksenmukaisesti. Poistoventtiiliin ei saa kiinnittää muita esineitä, esim. seinäkupua.
- Jos läpivirtauskuumentimen kanssa on ongelmia tai jos halutaan suurempaa veden virtausmäärää, voidaan poreenmuodostajan takana oleva EcoSmart® (virtauksenrajoitin) poistaa.

## Tekniset tiedot

### Kaluste on vakiona varustettu EcoSmart® (virtauksenrajoittimella)

Käyttöpaine:	maks. 1 MPa
Suosittelu käyttöpaine:	0,1 - 0,5 MPa
Koestuspaine:	1,6 MPa
	(1 MPa = 10 bar = 147 PSI)

Kuuman veden lämpötila: maks. 70 °C

Kuuman veden suosituslämpötila: 65 °C

Lämpödesinfektio: maks. 70 °C / 4 min

Tuote on suunniteltu käytettäväksi ainoastaan juomaveden kanssa!

## Merkin kuvaus



Älä käytä etikkahappopitoista silikonia!



**Säätö** (katso sivu 32)

Lämpötilan rajoittimen säätäminen. Emme suosittele käyttämään lämpötilan rajoitinta vedenlämmittimen (läpivirtauskuumennin) yhteydessä.



**Mitat** (katso sivu 36)



**Virtausdiagrammi** (katso sivu 36)

- ① sisältää EcoSmart®
- ② ilman EcoSmart®



**Varaosat** (katso sivu 38)

## Erityisvaruste (ei kuulu toimitukseen)



• Asennusavain #58085000 (katso sivu 33)



• Asennussarja (katso sivu 33)



**Puhdistus** (katso sivu 40)



**Käyttö** (katso sivu 35)

- Hansgrohe suosittelee, että ensimmäistä puolta litraa ei käytetä juomavetenä aamuisin eikä silloin, kun laitetta ei ole käytetty pitkään aikaan.
- Stagnaation välttämiseksi liitosputkissa täytyy pitkien käyttötaukojen jälkeen, kuitenkin vähintään kolmen päivän välein, hana kääntää kuumaan ja kylmään asentoon, kunnes on saavutettu tasainen ulostulolämpötila.



**Koestusmerkki** (katso sivu 35)



## Säkerhetsanvisningar

- △ Handskar ska bäras under monteringsarbetet så att man kan undvika kläm- och skärskador.
- △ Produkten får bara användas till kroppshygien med bad och dusch.
- △ Stora tryckskillnader mellan anslutningarna för varmt och kallt vatten måste utjämnas.

## Monteringsanvisningar

- Det måste undersökas om produkten har transportskador innan den monteras. Efter monteringen accepteras inga transport- eller ytskiktsskador.
- Ledningarna och blandaren måste monteras, spolats igenom och kontrolleras enligt de gällande normerna.
- De installationsriktlinjer som gäller i länderna ska följas.
- Avrinningsventilen får bara användas till det som den är avsedd för. Det är inte tillåtet att montera andra föremål, t.ex. en kåpa, vid avrinningsventilen.
- Om det är problem med vattenberedaren eller om större vattenflöde önskas kan EcoSmart® (flödeskontroll) som sitter bakom perlatorn tas bort.

## Tekniska data

### Blandare seriemässigt med EcoSmart® (flödeskontroll)

Driftstryck:	max. 1 MPa
Rek. driftstryck:	0,1 - 0,5 MPa
Tryck vid provtryckning:	1,6 MPa
	(1 MPa = 10 bar = 147 PSI)
Varmvattentemperatur:	max. 70 °C
Rek. varmvattentemp.:	65 °C
Termisk desinfektion:	max. 70 °C / 4 min
Produkten är enbart avsedd för dricksvatten!	

## Symbolförklaring



Använd inte silikon som innehåller ättiksyra!



### Justering (se sidan 32)

Ställa in varmvattenregleringen. Tillsammans med varmvattenberedare rekommenderas inte en varmvattenspär.



### Måttén (se sidan 36)



### Flödesschema (se sidan 36)

- ① med EcoSmart®
- ② utan EcoSmart®



### Reservdelar (se sidan 38)

## Specialtillbehör (medföljer ej leveransen)



- Monteringsnyckel #58085000 (se sidan 33)



- Installationskitt (se sidan 33)



## Rengöring (se sidan 40)



## Hantering (se sidan 35)

- Hansgrohe rekommenderar att den första halvlitern inte används som dricksvatten på morgonen eller efter längre perioder utan användning.
- För att undvika en stagnering i anslutningsledningarna måste blandaren öppnas och spolats kallt och varmt tills en jämn temperatur är uppnådd när den inte har använts på länge, dock minst var tredje dag.



## Testsigill (se sidan 35)





## Saugumo technikos nurodymai

- △ Apsaugai nuo užspaudimo ir įsijpavimo montavimo metu mūvėkite pirštines.
- △ Gaminys turi būti naudojamas tik maudymuisi, kūno higienai ir švarai palaikyti.
- △ Turi būti išlyginti šalto ir karšto slėgio nelygumai.

## Montavimo instrukcija

- Prieš montuojant būtina patikrinti, ar gaminys nebuvo pažeistas transportavimo metu. Sumontavus pretenzijos dėl transportavimo ir paviršiaus pažeidimų nepriimamos.
- Vamzdžiai ir sujungimai turi būti montuojami, plunami ir tikrinami pagal galiojančias normas.
- Laikykites atitinkamoje šalyje galiojančių direktyvų dėl įrengimo.
- Išleidimo vožtuvus gali būti naudojamas tik pagal savo paskirtį. Prie išleidimo vožtuvo draudžiama tvirtinti kitas dalis, pavyzdžiui, puskolones.
- Jei yra problemų su momentiniu vandens šildytuvu ar neužtenka vandens srauto, galima pašalinti už aeratoriaus esantį „EcoSmart®“ (vandens srauto ribotuvą).

## Techniniai duomenys

### Šios serijos maišytuvai turi EcoSmart® (vandens srauto ribotuvą)

Darbinis slėgis: ne daugiau kaip 1 MPa  
 Rekomenduojamas slėgis: 0,1 - 0,5 MPa  
 Bandomasis slėgis: 1,6 MPa  
 (1 MPa = 10 barų = 147 PSI)

Karšto vandens temperatūra: ne daugiau kaip 70°C  
 Rekomenduojama karšto vandens temperatūra: 65°C  
 Terminis dezinfekavimas: ne daugiau kaip 70°C / 4 min  
 Produktas skirtas tik geriamajam vandeniui!

## Simbolio aprašymas



Nenaudokite silikono, kurio sudėtyje yra acto rūgšties!



## Reguliavimas (žr. psl. 32)

Karšto vandens ribojimas. Kartu su cirkuliaciniais šildytuvais nerekomenduojama naudoti karšto vandens blokavimo įtaisų.



## Išmatavimai (žr. psl. 36)



## Pralaidumo diagrama (žr. psl. 36)

- ① su EcoSmart®
- ② be EcoSmart®



## Atsarginės dalys (žr. psl. 38)

### Specialūs priedai (nėra pridedama)



• Montavimo raktas #58085000 (žr. psl. 33)



• Montavimo rinkinys (žr. psl. 33)



## Valymas (žr. psl. 40)



## Eksploatacija (žr. psl. 35)

- Naudojant po ilgesnės pertraukos, „Hansgrohe“ rekomenduoja pirmo pusės litro vandens nevertoti kaip geriamojo.
- Kad neužsikistų prijungimo vamzdžiai, po ilgesnių naudojimo pertraukų bent kas tris dienas atverkite maišytuvą nustatę rankenėlę tiek į karšto, tiek į šalto vandens padėtį, kol pasieksite, kad tekančio vandens temperatūra bus pastovi.



## Bandymo pažyma (žr. psl. 35)



## Sigurnosne upute

- △ Prilikom montaže se radi sprječavanja prignječenja i posjekotina moraju nositi rukavice.
- △ Proizvod se smije primjenjivati samo za kupanje, tuširanje i osobnu higijenu.
- △ Velika razlika u pritisku između vruće i hladne vode mora biti izbalansirana.

## Upute za montažu

- Prije montaže mora se provjeriti je li proizvod oštećen prilikom transporta. Nakon ugradnje se ne priznaju nikakve reklamacije koje se odnose na površinska i transportna oštećenja.
- Cijevi i armatura moraju biti postavljeni, isprani i testirani prema važećim normama.
- Obvezno se moraju uvažiti propisi o instalacijama koji vrijede u dotičnoj zemlji.
- Odvodni ventil smije se koristiti samo namjenski. Pričvršćivanje drugih predmeta npr. polustubova na odvodnom ventilu nije dopušteno.
- Ako dolazi do problema s protočnim bojlerom ili se želi veći protok vode, može se ukloniti EcoSmart® (limitator protoka) lociran iza aeratora.

## Tehnički podatci

### Armatura ima serijski ugrađen EcoSmart® (limitator protoka)

Najveći dopušteni tlak:	tlak 1 MPa
Preporučeni tlak:	0,1 - 0,5 MPa
Probni tlak:	1,6 MPa
	(1 MPa = 10 bar = 147 PSI)
Temperatura vruće vode:	tlak 70°C
Preporučena temperatura vruće vode:	65°C
Termička dezinfekcija:	tlak 70°C / 4 min
Proizvod je koncipiran isključivo za pitku vodu!	

## Opis simbola



Nemojte koristiti silikon koji sadrži octenu kiselinu!



## Regulacija (pogledaj stranicu 32)

Namještanje limitera tople vode. U kombinaciji s protočnim bojlerima nije preporučljiva primjena sustava za blokiranje dotoka tople vode.



## Mjere (pogledaj stranicu 36)



## Dijagram protoka

(pogledaj stranicu 36)

- ① s limitatorom EcoSmart®
- ② bez limitatora EcoSmart®



## Rezervni dijelovi

(pogledaj stranicu 38)

## Posebni pribor (Nije sadržano u isporuci!)



- ključ za montažu #58085000 (pogledaj stranicu 33)



- Instalaterski kit (pogledaj stranicu 33)



## Čišćenje (pogledaj stranicu 40)

## Upotreba (pogledaj stranicu 35)

- Hansgrohe preporuča da ujutro ili nakon duljeg nekorisćenja prvih 1/2 litre vode ne upotrebljavate za piće.
- Kako bi se izbjegla stagnacija vode u priključnim cijevima, potrebno je nakon duljih prekida korišćenja, a najmanje jednom svakog trećeg dana, otvoriti armaturu u položaju vruće i hladne vode, sve dok se ne postigne ujednačena izlazna temperatura.



## Oznaka testiranja

(pogledaj stranicu 35)



## Güvenlik uyarıları

- △ Montaj esnasında ezilme ve kesilme gibi yaralanmaları önlemek için eldiven kullanılmalıdır.
- △ Ürün yalnızca banyo, hijyen ve beden temizliği amaçları doğrultusunda kullanılabilir.
- △ Sıcak ve soğuk su bağlantıları arasında büyük basınç farklılıkları varsa, bu basınç farklılıklarının dengelenmesi gerekir.

## Montaj açıklamaları

- Montaj işleminden önce ürün nakliye hasarları yönünden kontrol edilmelidir. Montaj işleminden sonra nakliye veya yüzey hasarları için sorumluluk üstlenilmemektedir.
- Boruların ve armatürün montajı, yıkanması ve kontrolü geçerli normlara göre yapılmalıdır.
- Ülkelerde geçerli kurulum yönetmeliklerine riayet edilmelidir.
- Drenaj valfi sadece amacına uygun şekilde kullanılabilir. Yarı sütun gibi diğer nesnelerin drenaj valfi üzerine sabitlenmesine izin verilmez.
- Sürekli akışlı su ısıtıcıları ile birlikte kullanımında problemler söz konusu ise veya akan su miktarının daha fazla olması isteniyorsa, perlatörün arka tarafındaki EcoSmart® (akış sınırlayıcısı) sökülüp çıkarılabilir.

## Teknik bilgiler

### Batarya EcoSmart® (akış sınırlayıcısı) ile birlikte seri olarak

İşletme basıncı:	azami 1 MPa
Tavsiye edilen işletme basıncı:	0,1 - 0,5 MPa
Kontrol basıncı:	1,6 MPa
	(1 MPa = 10 bar = 147 PSI)

Sıcak su sıcaklığı:	azami 70 °C
Tavsiye edilen su ısıtı:	65 °C
Termik dezenfeksiyon:	azami 70 °C / 4 dak
Ürün sadece şebeke suyu için tasarlanmıştır!	

## Simge açıklaması

 Asetik asit içeren silikon kullanmayın!

 **Ayarlama** (bakınız sayfa 32)

Sıcak su sınırlamasının ayarlanması. Sıcak su kilidinin sürekli ısıtıcıyla kullanılması tavsiye edilmez.

 **Ölçüleri** (bakınız sayfa 36)

 **Akış diyagramı** (bakınız sayfa 36)

- ① EcoSmart® dahil
- ② EcoSmart® hariç

 **Yedek Parçalar** (bakınız sayfa 38)

## Özel aksesuarlar

(Teslimat kapsamına dahil değildir)



- Montaj anahtarı #58085000 (bakınız sayfa 33)



- Montaj silikonu (bakınız sayfa 33)



**Temizleme** (bakınız sayfa 40)



**Kullanımı** (bakınız sayfa 35)

- Hansgrohe sabahları uzun durgunluk süresi sonrasında ilk yarım litre suyun içme suyu olarak kullanılmamasını önerir.
- Bağlantı hatlarında bir problem oluşumunu önlemek için, uzun süre kullanılmadığında, fakat en az her 3 günde bir armatür, dengeli bir çıkış sıcaklığı elde edilene kadar sıcak ve soğuk yönünde açılmalıdır.



**Kontrol işareti** (bakınız sayfa 35)



## Instrucțiuni de siguranță

- ⚠ La montare utilizați mănuși pentru evitarea contuziunilor și tăierii mâinilor.
- ⚠ Produsul poate fi utilizat doar pentru spălarea, menținerea igienei și curățarea corpului.
- ⚠ Diferențele de presiune mari între alimentarea cu apă rece și apă caldă trebuie echilibrate.

## Instrucțiuni de montare

- Înainte de instalare verificați, dacă produsul prezintă deteriorări de transport. După instalare garanția nu acoperă deteriorările de transport și cele de suprafață.
- Conductele și bateriile trebuie montate, spălate și verificate conform normelor în vigoare.
- Respectați reglementările referitoare la instalare valabile în țara respectivă.
- Supapa de scurgere poate fi utilizată doar conform destinației. Fixarea altor obiecte, de ex. a unui semi-stâlp la supapa de scurgere este interzisă.
- Dacă apar probleme cu boilerul instant sau dacă doriți un debit de apă mai mare, puteți să demontați unitatea EcoSmart® (limitatorul de debit), care se află în spatele suflătorului de aer.

## Date tehnice

### Bateria este dotată în serie cu EcoSmart® (limitator de debit)

Presiune de funcționare:	max. 1 MPa
Presiune de funcționare recomandată:	0,1 - 0,5 MPa
Presiune de verificare:	1,6 MPa
	(1 MPa = 10 bar = 147 PSI)
Temperatura apei calde:	max. 70 °C
Temperatura recomandată a apei calde:	65 °C
Dezinfecție termică:	max. 70 °C / 4 min

Produsul este destinat exclusiv pentru apă potabilă.

## Descrierea simbolurilor



Nu utilizați silicon cu conținut de acid acetic!



### Reglare (vezi pag. 32)

Reglarea limitatorului de apă caldă. Nu se recomandă folosirea unui limitator de apă caldă în combinație cu un boiler instant.



### Dimensiuni (vezi pag. 36)



### Diagrama de debit (vezi pag. 36)

- ① cu EcoSmart®
- ② fără EcoSmart®



### Piese de schimb (vezi pag. 38)

## Accesorii opționale

(nu este inclus în setul livrat)



- Cheie pentru montare #58085000 (vezi pag. 33)



- Chit de instalare (vezi pag. 33)



### Curățare (vezi pag. 40)



### Utilizare (vezi pag. 35)

- Hansgrohe vă recomandă, ca dimineața sau după perioade mai lungi de pauză să nu folosiți prima jumătate de litru de apă pentru băut.
- Pentru evitarea stagnerii apei în conductele de racord, după o pauză mai lungă de utilizare sau cel puțin la fiecare trei zile trebuie să deschideți robinetul în poziția cald și rece până ce temperatura apei va fi uniformă la ieșire.



### Certificat de testare (vezi pag. 35)





## Υποδειξεις ασφαλείας

- △ Για να αποφύγετε τραυματισμούς κατά τη συναρμολόγηση πρέπει να φοράτε γάντια.
- △ Το προϊόν επιτρέπεται να χρησιμοποιείται μόνο σαν μέσο λουτρού, υγιεινής και καθαρισμού του σώματος.
- △ Οι διαφορές της πίεσης μεταξύ της σύνδεσης κρύου και ζεστού νερού θα πρέπει να αντισταθμίζονται.

## Οδηγίες συναρμολόγησης

- Πριν τη συναρμολόγηση πρέπει να εξεταστεί το προϊόν για ζημιές μεταφοράς. Μετά την εγκατάσταση δεν αναγνωρίζονται ζημιές από τη μεταφορά ή επιφανειακές ζημιές.
- Οι σωλήνες και η μπαταρία πρέπει να τοποθετηθούν σύμφωνα με τα ισχύοντα πρότυπα, να τεθούν υπό πίεση και να δοκιμαστούν.
- Θα πρέπει να τηρούνται οι οδηγίες εγκατάστασης που ισχύουν σε κάθε κράτος.
- Η βαλβίδα εκροής επιτρέπεται να χρησιμοποιείται μόνο για την προβλεπόμενη χρήση. Η στερέωση άλλων αντικειμένων π.χ. μισής κολώνας στη βαλβίδα εκροής δεν επιτρέπεται.
- Εάν παρουσιαστεί πρόβλημα με τον ταχυθερμοσίφωνα ή όταν απαιτείται περισσότερο νερό, μπορεί να απομακρυνθεί ο EcoSmart® (μειωτής ροής), ο οποίος βρίσκεται πίσω από το φίλτρο του ρουξουιού.

## Τεχνικά Χαρακτηριστικά

### Μπαταρία μόνιμα εξοπλισμένη με EcoSmart® (μειωτής ροής)

Λειτουργία πίεσης: έως 1 MPa  
 Συνιστώμενη λειτουργία πίεσης: 0,1 - 0,5 MPa  
 Πίεση ελέγχου: 1,6 MPa  
 (1 MPa = 10 bar = 147 PSI)

Θερμοκρασία ζεστού νερού: έως 70 °C  
 Συνιστώμενη θερμοκρασία ζεστού νερού: 65 °C  
 Θερμική απολύμανση: έως 70 °C / 4 min

Το προϊόν έχει σχεδιαστεί αποκλειστικά για πόσιμο νερό!.

## Περιγραφή συμβόλων



Μην χρησιμοποιείτε σιλικόνη που περιέχει οξικό οξύ!



### Ρύθμιση (βλ. Σελίδα 32)

Ρύθμιση του δοσομετρητή ζεστού νερού. Δεν συνιστάται η διάταξη φραγής ζεστού νερού σε συνδυασμό με ταχυθερμοσίφωνα.



### Διαστάσεις (βλ. Σελίδα 36)



### Διάγραμμα ροής (βλ. Σελίδα 36)

- ① με EcoSmart®
- ② χωρίς EcoSmart®



### Ανταλλακτικά (βλ. Σελίδα 38)

### Ειδικά αξεσουάρ (δεν περιλαμβάνεται στον παραδοτέο εξοπλισμό)



• Κλειδί συναρμολόγησης #58085000 (βλ. Σελίδα 33)



• Κιτ εγκατάστασης (βλ. Σελίδα 33)



### Καθαρισμός (βλ. Σελίδα 40)



### Χειρισμός (βλ. Σελίδα 35)

- Η Hansgrohe συνιστά το πρωί ή μετά από μεγάλα χρονικά διαστήματα αχρησίας να μην χρησιμοποιείτε το πρώτο μισό λίτρο νερό σαν πόσιμο.
- Για να μη δημιουργηθεί φράξιμο στις συνδετήριες σωληνώσεις πρέπει η μπαταρία, όταν μεσολαβούν μεγάλα χρονικά διαστήματα χωρίς να χρησιμοποιείται, να ανοίγεται τουλάχιστον κάθε τρίτη ημέρα με εναλλαγή καυτού και κρύου νερού μέχρι να επιτευχθεί σταθερή θερμοκρασία νερού.



### Σήμα ελέγχου (βλ. Σελίδα 35)





## Varnostna opozorila

- △ Pri montaži je treba nositi rokavice, da se preprečijo poškodbe zaradi zmečkanja ali urezov.
- △ Ta izdelek se sme uporabljati le z namenom umivanja, vzdrževanja higiene in telesne nege.
- △ Velike razlike v tlaku med priključkom za mrzlo in priključkom za toplo vodo je potrebno izravnati.

## Navodila za montažo

- Pred montažo je treba izdelek preveriti glede morebitnih transportnih poškodb. Po vgradnji transportne ali površinske poškodbe ne bodo več priznane.
- Cevi in armaturo je treba montirati, izprati in preveriti po veljavnih standardih.
- Upoštevati je treba pravilnike o inštalacijah, ki veljajo v posamezni državi.
- Odtočni ventil se sme uporabljati le v skladu z namenom uporabe. Pritrditev drugih elementov na odtočni ventil, npr. polstebra, ni dovoljena.
- Če imate probleme s pretočnim grelnikom, ali če želite večji pretok vode, lahko odstranite EcoSmart® (omejevalnik pretoka), ki se nahaja za perlatorjem.

## Tehnični podatki

### Armaturo je serijsko opremljena z EcoSmart® (omejevalnikom pretoka)

Delovni tlak:	maks. 1 MPa
Priporočeni delovni tlak:	0,1 - 0,5 MPa
Preskusni tlak:	1,6 MPa

(1 MPa = 10 bar = 147 PSI)

Temperatura tople vode:	maks. 70 °C
Priporočena temperatura tople vode:	65 °C
Termična dezinfekcija:	maks. 70 °C / 4 min

Proizvod je zasnovan izključno za sanitarno vodo!

## Opis simbola



Ne smete uporabiti silikona, ki vsebuje ocetno kislino!



## Justiranje (glejte stran 32)

Nastavitev omejevalnika tople vode. V povezavi s pretočnimi grelniki uporaba zapore tople vode ni priporočljiva.



## Mere (glejte stran 36)



## Diagram pretoka (glejte stran 36)

- ① z omejevalnikom pretoka EcoSmart®
- ② brez omejevalnika pretoka EcoSmart®



## Rezervni deli (glejte stran 38)

## Poseben pribor (Ni vključeno)



- Montažni ključ #58085000 (glejte stran 33)



- Komplet za montažo (glejte stran 33)



## Čiščenje (glejte stran 40)



## Upravljanje (glejte stran 35)

- Hansgrohe priporoča, da zjutraj ali po daljšem času stagnacije prvega pol litra vode ne uporabite kot pitno vodo.
- Da se prepreči stagniranje v priključnih vodih, je treba po daljših premorih ter vsaj vsak tretji dan odpreti armaturo v položaju vroče in hladno, dokler ni dosežena enakomerna iztočna temperatura.



## Preskusni znak (glejte stran 35)



## Ohutusjuhised

- △ Kandke paigaldamisel muljumis- ja löikevigastuste vältimiseks kindaid.
- △ Toodet tohib kasutada ainult pesemis-, hügieeni- ja kehapuhastamisesmärkidel.
- △ Kui külma ja kuuma vee ühenduste surve on väga erinev, tuleb need tasakaalustada.

## Paigaldamisjuhised

- Enne paigaldamist tuleb toodet kontrollida transpordikahjustuste osas. Pärast paigaldamist ei tunnustata enam transpordi- või pinnakahjustuste kaebuseid.
- Voolikute ja segisti paigaldamisel, loputamisel ja kontrollimisel tuleb lähtuda kehtivatest normatiividest.
- Vastavas riigis kehtivaid paigalduseeskirju tuleb järgida.
- Tühjenduskraani võib kasutada ainult ettenähtud viisil. Muude esemete, nt sifooni, kinnitamine tühjenduskraani külge ei ole lubatud.
- Kui esineb probleeme läbivooluhooleiga või kui soovitakse, et vee läbivool oleks suurem, tuleks sõela taga asuv EcoSmart® (veehulgapiiraja) eemaldada.

## Tehnilised andmed

### Segistisari on toodetud koos EcoSmart® (veehulgapiirajaga)

Töörõhk	maks. 1 MPa
Soovitav töörõhk:	0,1 - 0,5 MPa
Kontrollsurve:	1,6 MPa
	(1 MPa = 10 baari = 147 PSI)
Kuuma vee temperatuur:	maks. 70 °C
Soovitav kuuma vee temperatuur:	65 °C
Termiline desinfitatsioon:	maks. 70 °C / 4 min
Toode on ette nähtud eranditult joogivee jaoks!	

## Sümbolite kirjeldus



Ärge kasutage äädikhapet sisaldavat silikooni!



### Reguleerimine (vt lk 32)

Sooja vee piirangu seadistamine. Ühenduses boileritega ei ole sooja vee blokeeringu soovitatav.



### Mõõtude (vt lk 36)



### Läbivooludiagramm (vt lk 36)

- ① EcoSmart® olemas
- ② EcoSmart® puudub



### Varuosad (vt lk 38)

## Spetsiaalne lisavarustus

(ei sisaldu komplektis)



• Montaaživõti #58085000 (vt lk 33)



• Paigalduskomplekt (vt lk 33)



### Puhastamine (vt lk 40)



### Kasutamine (vt lk 35)

- Hansgrohe soovib mitte kasutada esimest poolt liitrit hommikuti või pärast pikemat seisakuaega joogi-veena.
- Et vältida ühendusjuhtmete ummistumist, tuleb pärast pikemat pausi kasutamises, kuid hiljemalt igal kolmandal päeval, avada armatuur käepideme kuuma ja külma asendis, kuni väljuv vesi on püsiva temperatuuriga.



### Kontrollsertifikaat (vt lk 35)



## Drošības norādes

- △ Montāžas laikā, lai izvairītos no saspiedumiem un iegriezumiem, nepieciešams nēsāt cimdus.
- △ Šo produktu drīkst izmantot tikai, lai mazgātos, higiēnai un ķermeņa tīrīšanai.
- △ Jāizslidzina spiediena atšķirības starp aukstā un karstā ūdens pievadiem.

## Norādījumi montāžai

- Pirms montāžas nepieciešams pārbaudīt, vai produktam transportēšanas laikā nav radušies bojājumi. Pēc iebūvēšanas bojājumi, kas radušies transportēšanas laikā, vai virsmas bojājumi netiek atzīti.
- Cauruļvadi un armatūra ir jāuzstāda, jāizskalo un jāpārbauda saskaņā ar spēkā esošajiem standartiem.
- Jāievēro attiecīgās valstīs spēkā esošās montāžas prasības.
- Noteces vārstu drīkst izmantot tikai noteiktajam mērķim. Pie noteces vārsta aizliegts piestiprināt citus priekšmetus, piemēram, puskolonnas.
- Ja rodas problēmas ar caurteces sildītāju vai ja ūdens plūsma nav pietiekami spēcīga, EcoSmart® (caurteces ierobežotāju), kas atrodas aiz aeratora, drīkst noņemt.

## Tehniskie dati

### Jaucējkrāns tiek ražots kopā ar EcoSmart® (caurteces ierobežotāju)

Darba spiediens:	maks. 1 MPa
Ieteicamais darba spiediens:	0,1 - 0,5 MPa
Pārbaudes spiediens:	1,6 MPa
	(1 MPa = 10 bar = 147 PSI)

Karstā ūdens temperatūra:	maks. 70 °C
Ieteicamā karstā ūdens temperatūra:	65 °C
Termiskā dezinfekcija :	maks. 70 °C / 4 min

Izstrādājums ir paredzēts tikai dzeramajam ūdenim!

## Simbolu nozīme



Neizmantojiet silikonu, kas satur etiķskābi!



### Ieregulēšana (skat. lpp. 32)

Karsta ūdens ierobežotāja regulēšana. Kopā ar caurteces sildītājiem nav ieteicams izmantot ūdens bloķētāju.



### Izmērus (skat. lpp. 36)



## Caurplūdes diagramma

(skat. lpp. 36)

- ① ar EcoSmart®
- ② bez EcoSmart®



## Rezerves daļas (skat. lpp. 38)

## Speciāli aksesuāri

(komplektā netiek piegādāts)



- Montāžas atslēga #58085000 (skat. lpp. 33)



- Instalācijas piederumi (skat. lpp. 33)



## Tīrīšana (skat. lpp. 40)



## Lietošana (skat. lpp. 35)

- Hansgrohe iesaka no rīta vai pēc ilgākiem pārtraukumiem nelietot pirmo puslitru ūdens dzeršanai.
- Lai novērstu stagnāciju pieslēgšanas vados, pēc ilgākiem lietošanas pārtraukumiem, taču vismaz reizi trīs dienās, atvēriet armatūru karstā un aukstā roktura stāvoklī.



## Pārbaudes zīme (skat. lpp. 35)





## Sigurnosne napomene

- △ Prilikom montaže se radi sprečavanja prignječenja i posekوتا moraju nositi rukavice.
- △ Proizvod sme da se koristi samo za kupanje, tuširanje i ličnu higijenu.
- △ Velika razlika u pritisku između vruće i hladne vode mora biti izbalansirana.

## Instrukcije za montažu

- Pre montaže se mora proveriti da li je proizvod oštećen pri transportu. Nakon ugradnje se ne priznaju nikakve reklamacije koje se odnose na površinska i transportna oštećenja.
- Vodovi i armatura moraju biti postavljeni, isprani i testirani prema važećim normama.
- Treba se pridržavati propisa koji u određenim zemljama važe za instalacije.
- Odvodni ventil sme da se koristi samo namenski. Pričvršćivanje drugih predmeta npr. polustubova na odvodnom ventilu nije dozvoljeno.
- Ukoliko se pojave problemi sa protočnim bojlerom ili se želi veći protok vode, onda EcoSmart® (ograničavač protoka vode), koji je smešten iza aeratora, može da se ukloni.

## Tehnički podaci

### Ove armature imaju serijski ugrađen EcoSmart® (ograničavač protoka vode)

Radni pritisak:	maks. 1 MPa
Preporučeni radni pritisak:	0,1 - 0,5 MPa
Probni pritisak:	1,6 MPa
	(1 MPa = 10 bar = 147 PSI)
Temperatura vruće vode:	maks. 70 °C
Preporučena temperatura vruće vode:	65 °C
Termička dezinfekcija:	maks. 70 °C / 4 min

Proizvod je koncipiran isključivo za pijaću vodu!

## Opis simbola



Nemojte koristiti silikon koji sadrži sirćetnu kiselinu!



### Podešavanje (vidi stranu 32)

Podešavanje ograničivača tople vode. U kombinaciji sa protočnim bojlerima ne preporučuje se primena sistema za blokiranje dotoka tople vode.



### Mere (vidi stranu 36)



### Dijagram protoka (vidi stranu 36)

- ① sa ograničavačem EcoSmart®
- ② bez ograničivača EcoSmart®



### Rezervni delovi (vidi stranu 38)

### Poseban pribor (Nije sadržano u isporuci)



- ključ za montažu #58085000 (vidi stranu 33)



- Instalaterski komplet (vidi stranu 33)



### Čišćenje (vidi stranu 40)



### Rukovanje (vidi stranu 35)

- Hansgrohe preporučuje da ujutru ili nakon dužeg nekorišćenja prvih pola litre vode ne koristite za piće.
- Da se voda u priključnim cevima ne bi ustajala, potrebno je nakon dužih pauza u korišćenju, a najmanje jednom svakog trećeg dana, otvoriti armaturu u položaju vruće i hladne vode, sve dok se temperatura na izlazu ne ujednači.



### Ispitni znak (vidi stranu 35)



## Sikkerhetshenvisninger

- △ Bruk hansker under montasjen for å unngå klem- og kuttskader.
- △ Produktet skal kun brukes for bade-, hygiene- og kroppshygiene.
- △ Store trykkdifferanser mellom kaldt- og varmtvannstilkoblinger skal utlignes.

## Montagehvisninger

- Før montasjen skal produktet sjekkes for transportskader. Etter monteringen aksepteres ikke noen transport- eller overflateskader.
- Ledningene og armaturen skal monteres, spyles og sjekkes iht. de gyldige normer.
- Gjeldende retningslinjer for rørleggerarbeid i de enkelte land skal følges.
- Utløpsventilen skal kun brukes på forskriftsmessig måte. Feste av andre gjenstander, som f.eks. en halvsøyle, til utløpsventilen er ikke tillatt.
- Ved problemer med gjennomstrømningsvarmer, eller når man ønsker en større vanngjennomstrømning, kan EcoSmart® (gjennomstrømningsbegrenser) fjernes. Den sitter bak luftdysene.

## Tekniske data

### Armatur er standardmessig utstyrt med EcoSmart® (gjennomstrømningsbegrenser)

Driftstrykk	maks. 1 MPa
Anbefalt driftstrykk:	0,1 - 0,5 MPa
Prøvetrykk	1,6 MPa

(1 MPa = 10 bar = 147 PSI)

Varmtvannstemperatur	maks. 70 °C
Anbefalt temperatur for varmt vann	65 °C
Termisk desinfisering:	maks. 70 °C / 4 min

Produktet er utelukkende designet for drikkevann!

## Symbolbeskrivelse



Ikke bruk silikon som inneholder eddiksyre!



### Justering (se side 32)

Innstilling av varmtvannsbegrensning. I forbindelse med gjennomstrømningsvarmere er det ikke anbefalt å bruke en varmtvannspærre.



### Mål (se side 36)



### Gjennomstrømningsdiagram (se side 36)

- ① med EcoSmart®
- ② uten EcoSmart®



### Serviceleder (se side 38)

### Ekstratilbehør (ikke med i leveransen)



- Montasjenøkkel #58085000 (se side 33)



- Installasjonskitt (se side 33)



### Rengjøring (se side 40)



### Betjening (se side 35)

- Om morgen og etter lengre stagnasjonstider anbefaler Hansgrohe å ikke bruke den første halvliteren som drikkevann.
- For å unngå stagnasjon i tilkoblingsledningene, må du etter lengre tids brukspause - men minst hver tredje dag - åpne armaturet i stilling varm og kald til det nås en jevn utløpstemperatur.



### Prøvermerke (se side 35)



## Указания за безопасност

- △ При монтажа трябва да се носят ръкавици, за да се избегнат наранявания поради притискане или порязване.
- △ Позволено е използването на продукта само за къпане, хигиена и цели на почистване на тялото.
- △ Големите разлики в налягането между изводите за студената и топлата вода трябва да се изравняват.

## Указания за монтаж

- Преди монтажа продуктът трябва да се провери за транспортни щети. След монтажа не се признават транспортни или повърхностни щети.
- Тръбопроводите и арматурата трябва да се монтират, промият и проверят в съответствие с валидните норми.
- Трябва да бъдат спазвани валидните в съответните страни предписания за инсталиране.
- Използването на клапана за отвеждане е позволено само по предназначение. Не е допустимо закрепването на други предмети, напр. на полуколони към клапана за отвеждане.
- При проблеми с проточния нагревател или когато желаете по-голяма пропускателна способност на водата, може да отстраните EcoSmart® (ограничителя на протичане), който се намира зад аератора.

## Технически данни

### Арматурата е оборудвана серийно с EcoSmart® (ограничител на протичане)

Работно налягане: макс. 1 МПа  
 Препоръчително работно налягане: 0,1 - 0,5 МПа  
 Контролно налягане: 1,6 МПа  
 (1 МПа = 10 bar = 147 PSI)  
 Температура на горещата вода: макс. 70 °С  
 Препоръчителна температура на горещата вода:  
 65 °С  
 Термична дезинфекция: макс. 70 °С / 4 мин  
 Продуктът е разработен само за питейна вода!

## Описание на символите



Не използвайте силикон, съдържащ оцетна киселина!



## Юстиране (вижте стр. 32)

Настройка на ограничителя за топлата вода. Във връзка с проточни нагреватели не се препоръчва блокировка за топлата вода



## Размери (вижте стр. 36)



## Диаграма на потока (вижте стр. 36)

- ① с EcoSmart®
- ② без EcoSmart®



## Сервизни части (вижте стр. 38)

## Специални принадлежности

(не се съдържа в обема на доставка)



- Монтажен ключ #58085000 (вижте стр. 33)



- Инсталационен кит (вижте стр. 33)



## Почистване (вижте стр. 40)



## Обслужване (вижте стр. 35)

- Hansgrohe препоръчва, сутрин и след по-продължително спиране първият половин литър да не се използва като питейна вода.
- За да се избегне застои в свързващите тръбопроводи, след по-продължителни прекъсвания на използването, но минимум на всеки трети ден, арматурата трябва да се отваря в положение на дръжките горещо и студено, докато се постигне постоянна изходяща температура.



## Контролен знак (вижте стр. 35)



## Udhëzime sigurie

- △ Për të evituar lëndimet e pickimeve ose të prerjeve gjatë procesit të montimit duhet që të vishni doreza.
- △ Produkti duhet të përdoret vetëm qëllimet e banjave, të higjienës dhe të larjes së trupit.
- △ Ndryshimet e mëdha të presionit mes lidhjeve të ujit të ftohtë dhe atij të ngrohtë duhen ekuilibruar.

## Udhëzime për montimin

- Përpara montimit duhet që produkti të kontrollohet për dëmtime nga transporti. Pas instalimit nuk do të njihet asnjë dëmtim nga transporti ose dëmtim i sipërfaqes.
- Tubacionet dhe rubinetet duhet që të montohen, të shpëlahen dhe të kontrollohen sipas standardeve në fuqi
- Duhet të respektohen linjat udhëzuese të instalimit, të vlefshme për vendet respektive.
- Ventilin dalës mund të përdoret vetëm për përcaktimin teknik të përdorimit të tij. Nuk lejohet përforsimi apo vendosja e objekteve të tjera në ventilin dalës si p.sh. të një gjysëm harku.
- Nëse lindin probleme me ngrohësin e ujit ose nëse dëshironi të keni më shumë qarkullim uji, atëherë EcoSmart® (kufizuesi i qarkullimit të ujit), i cili ndodhet pas ajrosësit, mund të çmontohet.

## Të dhëna teknike

### Rubineti është i pajisur si standard me EcoSmart® (Kufizues qarkullimi)

Presioni gjatë punës maks. 1 MPa  
 Presioni i rekomanduar: 0,1 - 0,5 MPa  
 Presioni për provë: 1,6 MPa  
 (1 MPa = 10 bar = 147 PSI)

Temperatura e ujit të ngrohtë maks. 70 °C  
 Temperatura e rekomanduar e ujit të ngrohtë: 65 °C  
 Dezinfektim Termik: maks. 70 °C / 4 min

Produkti është projektuar ekskluzivisht për ujë të pijshëm!

## Përshkrimi i simbolit



Mos përdorni silikon që në përbërje ka acid acetik.



**Justimi** (shih faqen 32)

Rregullimi i kufizimit me ujë të nxehtë. Nje kombinim me një bojler ujit nuk është i rekomanduar.



**Përmasat** (shih faqen 36)



## Diagrami i qarkullimit

(shih faqen 36)

- ① me EcoSmart®
- ② pa EcoSmart®



**Pjesët e servisit** (shih faqen 38)

## Pajisje të posaçme

(nuk përfshihet në vëllimin e furnizimit)



- Çelësi i montimit #58085000 (shih faqen 33)



- Stuko për instalim (shih faqen 33)



**Pastrimi** (shih faqen 40)



**Përdorimi** (shih faqen 35)

- Hangerohe rekomandon që në mëngjes ose pas periudhave të gjata që gjysmë litri i parë mos të pihet
- Për të shmangur stanjacion në linjat lidhje duhet të bëj një pauzë pas përdorimit të zgjatur, por të paktën çdo ditë e tretë, valvula në pozitë të hapur të trajtuar të nxehtë dhe të ftohtë që të arrihet një temperaturë konstante prizë.



**Shenja e kontrollit** (shih faqen 35)



## رسم للصراف (راجع صفحة 36)



- ① → EcoSmart  
② بدون EcoSmart

## قطع الغيار (راجع صفحة 38)



### ملحقات خاصة

(غير مدرج مع المحتويات المسلمة)

- مفتاح التركيب #58085000



(راجع صفحة 33)

- طقم تركيب (راجع صفحة 33)



## التنظيف (راجع صفحة 40)



## التشغيل (راجع صفحة 35)



- ننصح شركة هانزجر وهي Hansgrohe بعدم استخدام أول نصف لتر من الماء لغرض الشرب وذلك في الصباح أو بعد توقف استخدام الماء لفترات طويلة نسبياً.

- لتفادي انسداد التوصيلات يجب بعد فترات توقف طويلة وضع خلاط المياه في الوضع المفتوح للساخن والبارد بحد أدنى كل ثلاثة أيام حتى يتم الوصول لدرجة حرارة مياه متوازنة للمياه.

## شهادة اختبار (راجع صفحة 35)



## تنبيهات الأمان



يجب ارتداء قفازات لليد أثناء التركيب لتجنب حدوث أخطار الإنحشار أو الجروح.

لا يجب استخدام المنتج إلا في أغراض الاستحمام والأغراض الصحية وأغراض تنظيف الجسم.

يجب أن يكون تيار الماء الساخن والماء البارد متعادلين في الضغط.

## تعليمات التركيب

- قبل القيام بعملية التركيب، يجب فحص المنتج للتأكد من خلوه من أية تلفيات ناتجة عن النقل. بعد القيام بعملية التركيب، لن يتم الاعتراف بوجود أية تلفيات سطحية أو تلفيات ناتجة عن عملية النقل.
- يجب تركيب وغسيل واختبار التوصيلات وخلطات المياه طبقاً للمعايير السارية.
- يجب مراعاة القواعد الخاصة بالتركيب وأعمال السباكة وفقاً للوائح الخاصة بكل بلد.
- يجب استخدام صمام الصرف للأغراض المحددة فقط. غير مسموح بتثبيت أشياء أخرى على صمام الصرف - على سبيل المثال نصف عامود.
- إذا تسبب سخان الماء الجاري في أية مشكلات أو في حالة الرغبة في وجود تدفق أكثر للماء، يجب فك EcoSmart\* (محدد تدفق المياه) الموجود خلف تجهيزة التهوية.

## المواصفات الفنية

يتم بشكل قياسي إنتاج الخلاط هذا مع EcoSmart\* (محدد تدفق المياه)

- ضغط التشغيل: الحد الأقصى 1 ميجاباسكال
- ضغط التشغيل الموصى به: 0,1 - 0,5 ميجاباسكال
- ضغط الاختبار: 1,6 ميجاباسكال
- (1 ميجاباسكال = 10 بار = 147 PSI)
- درجة حرارة الماء الساخن: الحد الأقصى 70°C
- درجة الحرارة الموصى بها للماء الساخن: 65°C
- تعقيم حراري: الحد الأقصى 70°C / 4 الدقيقة
- المنتج مخصص فقط لماء الشرب!

## وصف الرمز

هام! لا تستخدم السليكون الذي يحتوي على أحماض!



## الضبط (راجع صفحة 32)



ضبط تحديد المياه الدافئة. لا ينصح باستخدام محدّد المياه الدافئة مع سخان المياه الوتقي.

## أبعاد (راجع صفحة 36)





## Biztonsági utasítások

- △ A szerelésnél a zúzódasok és vágási sérülések elkerülése érdekében kesztyűt kell viselni.
- △ A terméket csak fürdéshez, mosakodáshoz, és egészségügyi tisztálkodáshoz szabad használni.
- △ A hidegvíz- és a melegvíz-csatlakozások közötti nagy nyomáskülönbséget kikell egyenlíteni!

## Szerelési utasítások

- A szerelés előtt ellenőrizni kell, hogy a terméknek nincs-e szállítási sérülése. Beépítés után a szállítási- vagy felületi sérüléseket nem ismerik el.
- A vezetékeket és a csaptelepet az érvényes szabványoknak megfelelően kell felszerelni, öblíteni és ellenőrizni
- Az egyes országokban érvényes installációs irányelveket be kell tartani.
- A lefolyószelpeket csak rendeltetészerűen szabad használni. Más tárgyak, pl. mosdóláb, rögzítése a lefolyószelpehez nem megengedett.
- Ha problémák adódnak az átfolyós vízmelegítővel vagy nagyobb átfolyó vízmennyiségre van szükség, akkor az EcoSmart® (átfolyáskorlátozó) eltávolítható a perlátor mögül.

## Műszaki adatok

### A csaptelep szériakivitelben el van látva

### EcoSmart® (átfolyáskorlátozó) berendezéssel

Üzemi nyomás: max. 1 MPa

Ajánlott üzemi nyomás: 0,1 - 0,5 MPa

Nyomáspróba: 1,6 MPa

(1 MPa = 10 bar = 147 PSI)

Forróvíz hőmérséklet: max. 70 °C

Forróvíz javasolt hőmérséklete: 65 °C

Termikus fertőtlenítés: max. 70 °C / 4 perc

A terméket kizárólag ivóvízhez tervezték!

## Szimbólumok leírása



Ne használjon ecetsavtartalmú szilikon!



**Beállítás** (lásd a oldalon 32)

A meleg víz korlátozás beállítása. Átfolyós vízmelegítőknél meleg víz korlátozó használata nem ajánlott.



**Méretet** (lásd a oldalon 36)



**Átfolyási diagramm**

(lásd a oldalon 36)

① EcoSmart® berendezéssel

② EcoSmart® nélkül



**Tartozékok** (lásd a oldalon 38)

## Egyéb tartozék

(a szállítási egység nem tartalmazza)



- Szerelőkulcs #58085000 (lásd a oldalon 33)



- szaniter szilikon (lásd a oldalon 33)



**Tisztítás** (lásd a oldalon 40)



**Használat** (lásd a oldalon 35)

- A csaptelepeken átfolyt víz hőmérséklete fogyasztás-szerű szánt víz esetében a 65 °C-ot nem haladhatja meg. A csaptelep nem eredményezheti az emberi fogyasztásra (pl. ivás és főzés céljából) szánt víz minőségromlását.
- Beüzemelés és üzemszünetek után szigorúan be kell tartani a használati útmutatóban leírtakat. Beüzemeléskor a csaptelepet át kell öblíteni, legalább 2 percig történő hideg- és melegvízes folyatást javasunk. Minimum 1 napos üzemszünet után fogyasztás előtt a csaptelepben stagnáló hideg- illetve melegvíz fogyasztása nem javasolt, a csaptelepben stagnáló vizet ki kell engedni, legalább 2 perces folyatás javasolt. A kifolyatás során nyert vizet ivóvízként, illetve ételkészítési céllal felhasználni nem szabad.
- Tekintettel arra, hogy a forró víz fémoldó képessége a hideg víznél nagyobb, emiatt főzés ivás céljából az OKI a hideg víz használatát javasolja.
- A csaptelepek perlátorát javasolt havonta vízkőteleníteni, illetve fertőtleníteni. A csaptelepek tisztítása, fertőtlenítése során kizárólag olyan vegyszer alkalmazható, amely megfelel a 201/2001. (X.25) Kormányrendelet, illetve a 38/2003. (VII.7) ÉSZCsM-FVM-KvVM együttes rendeletben leírtaknak.
- A perlátor működési elvéből adódóan jelentős aeroszolt képez, így Legionella expozíció szempontjából fokozott kockázatot jelent. Ezért alkalmazása nem javasolt az egészségügyi intézmények fekvőbeteg ellátó szobáiban, illetve minden olyan helyen, ahol a hideg és / vagy használati melegvíz Legionella csíraszama eléri a 49/2015 (XI.6.) EMMI rendelet alapján meghatározott beavatkozási szintet.



**Vizsgajel** (lásd a oldalon 35)



## ⚠ 安全上の注意

- △ 施工の際は手を挟んだり怪我をしないように、手袋をはめてください。
- △ この製品は、体や手を洗う等の製品本来の目的以外には使用しないでください。
- △ 給水・湯の圧力差は0.1(MPa)以内としてください。

## 施工上の注意

- 製品の施工前に輸送でのダメージがないか確認してください。施工後のキズ等のお申し出はお断りさせて頂いています。
- 配管と水栓は、関連法規に従って施工、洗浄、および試験を行ってください。
- 施工行う地域に適用される関連法規をお守りください。
- 排水栓は、本来の使用目的以外に使用しないでください。その他の部品、例えば排水管カバー(semi-pedestal)等を直接取付けしないでください。
- 流量が少なく給湯機の着火に問題がある場合や、流量を増やしたいときは、エアレーターの後ろにあるEcoSmart® (流量リミッター) を取り外すことができます。

## 技術資料

### EcoSmart® (流量リミッター) 付きの水栓

使用圧力:	最大 1 MPa
推奨使用水圧:	0,1 - 0,5 MPa
耐圧試験圧力:	1,6 MPa
	(1 MPa = 10 bar = 147 PSI)
給湯温度:	最大 70°C
推奨給湯温度:	65°C
お湯による高温消毒:	最大 70°C / 4 分

この製品は飲料水での使用が前提となっています  
(日本においては水道法に適合する飲料水)!

## アイコンの説明



酢酸系シリコンをご使用にならないでください!



**調整** (次のページを参照 32)

お湯の流量制限の設定方法。瞬間湯沸かし器をご利用の際はお湯の流量制限はしないでください。



**寸法** (次のページを参照 36)



**流量曲線図** (次のページを参照 36)

- ① エコスマート (EcoSmart®) 機能付き
- ② EcoSmart®機能なし



**スペアパーツ** (次のページを参照 38)

## スペシャルパーツ (別手配部品)



- 特殊工具 #58085000  
(次のページを参照 33)



- 施工用副資材 (次のページを参照 33)

## お手入れ方法

(次のページを参照 40)



**使用方法** (次のページを参照 35)

- ハンズグローエは、朝または長い間使用されなかった後に吐水する最初の0.5リットルは飲料水として使用しないことをお勧めします。
- 配管内の水の停滞を避けるために、水栓は最低3日ごとにハンドルを湯・水各々位置で開き、温度が一定になるまで吐水を行ってください。



**認証について** (次のページを参照 35)

**施工方法** (次のページを参照 32)

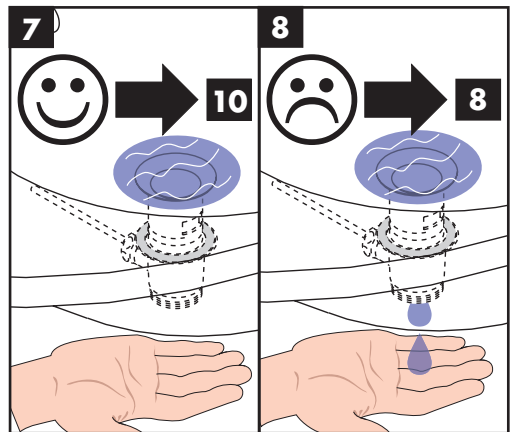
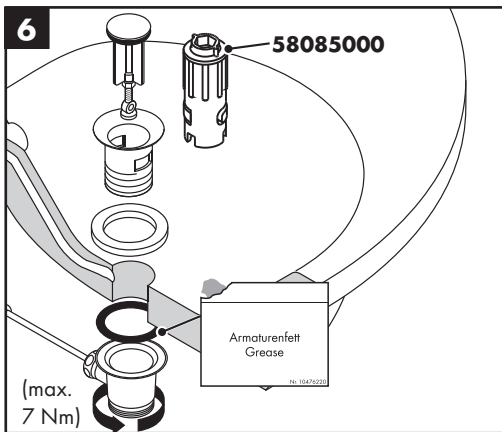
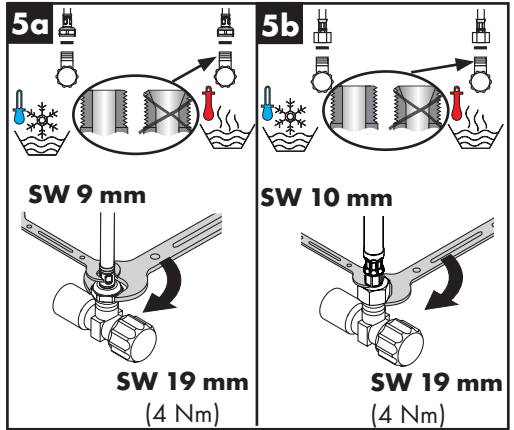
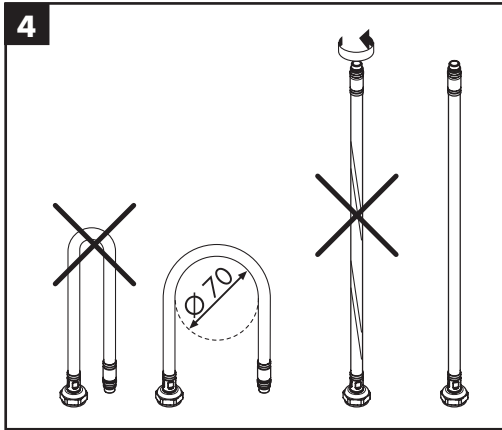
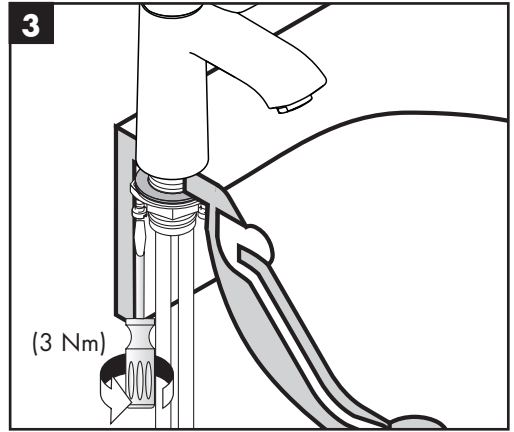
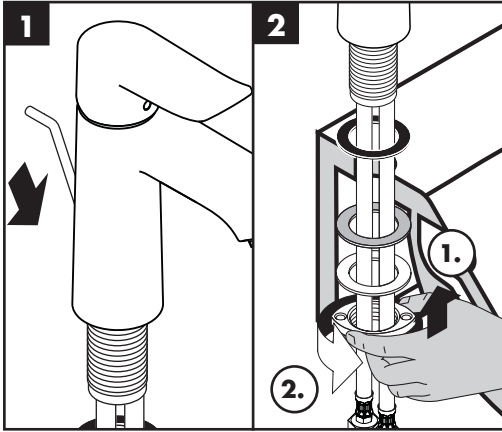



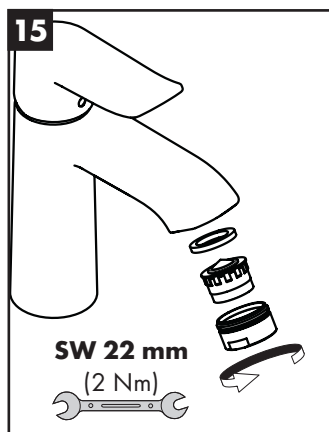
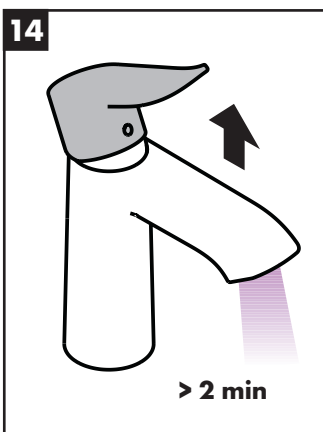
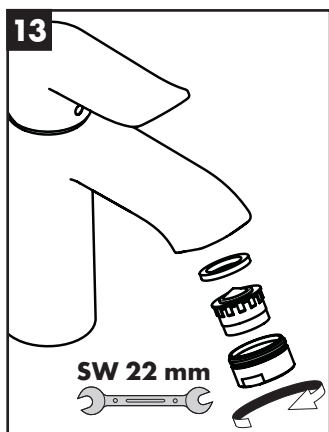
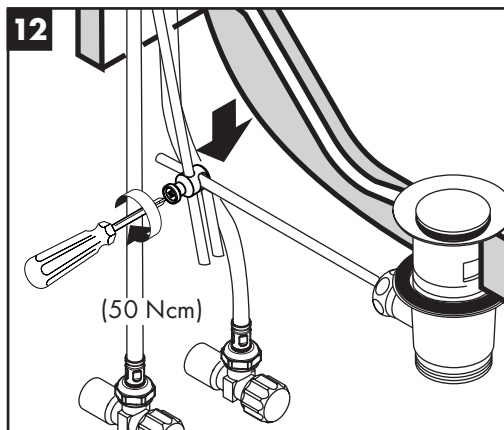
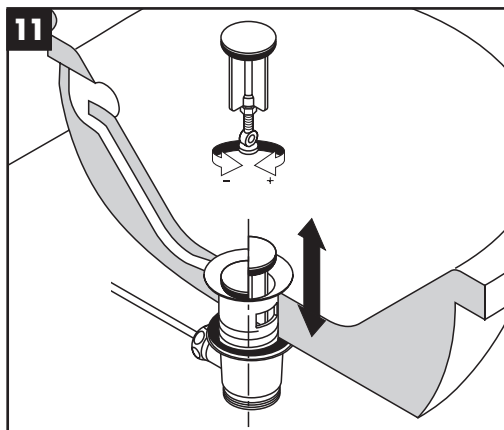
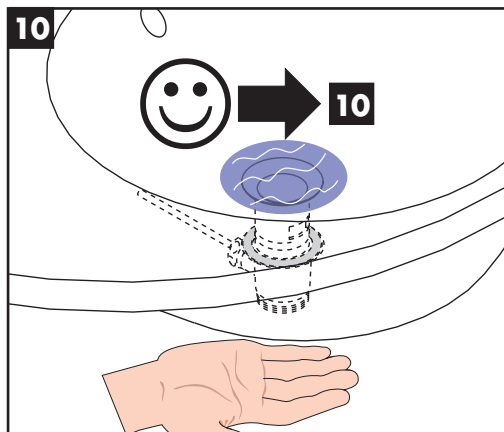
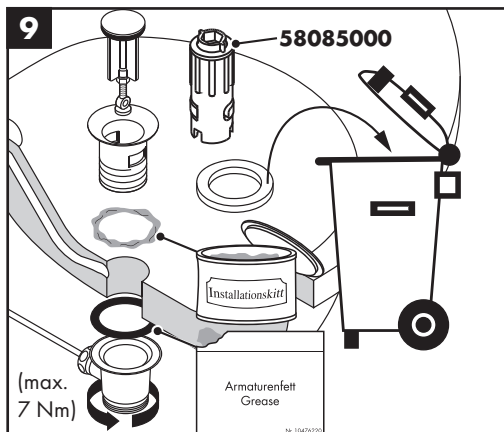

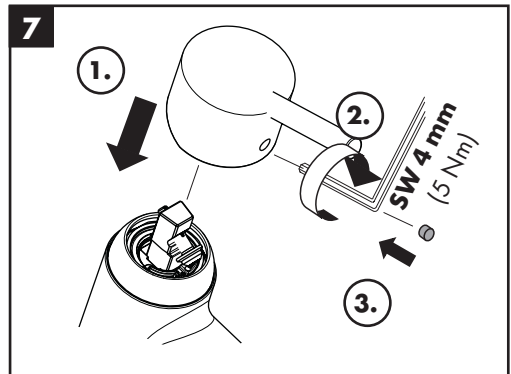
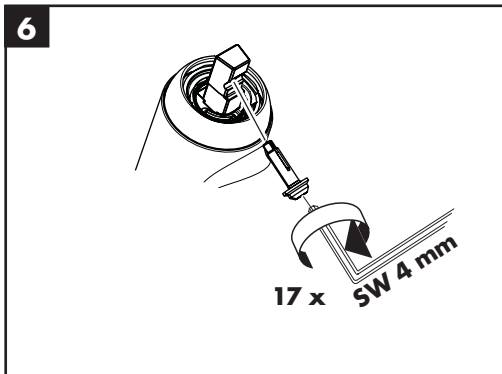
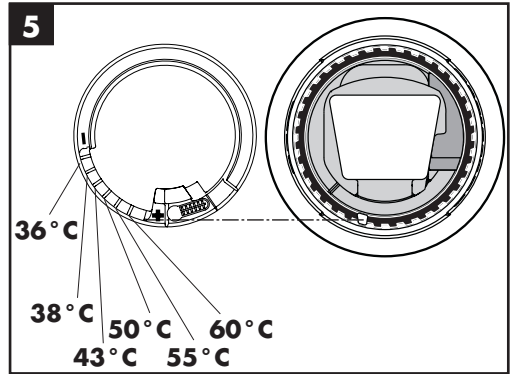
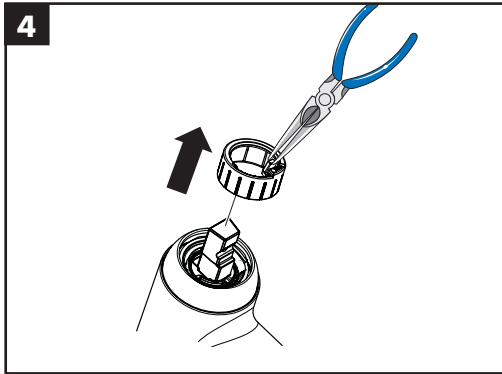
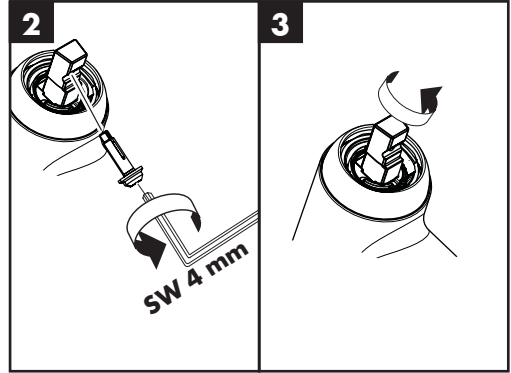
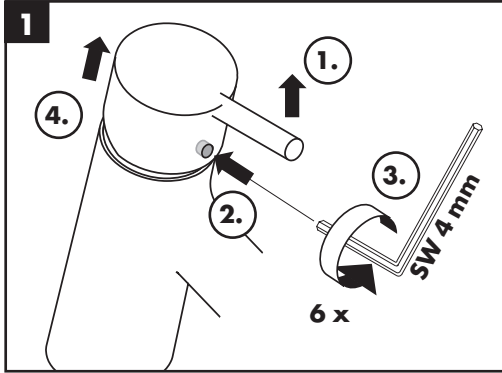



**Metris 31080000 / 31082000 / 31084000 /  
31088000 / 31183000 / 31184000 / 31185000 /  
31186000 / 31280000 / 31045000**

**Metris CoolStart 31121000**

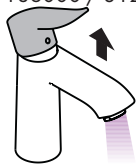

öffnen / ouvert / open / aperto / abierto / open / åbne / abrir /  
otworzyć / otevřít / otvorit / 开 / открыть / nyitás / avaaminen /  
öppna / atidaryti / Отваранje / açmak / deschide / ανοικτό / odpreti /  
avage / atvērt / otvoriti / åpne / отваряне / hare / فتح / 開く

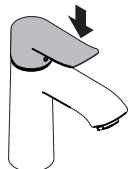

schließen / fermé / close / chiudere / cerrar / sluiten / lukke / fechar /  
zamknąć / zavřít / uzavrieť / 关 / закрыть / bezárás / sulkeminen /  
stänga / uždaryti / Zatvaranje / kapatmak / închide / κλειστό / zapreti /  
sulgege / aizvērt / zatvori / lukke / затваряне / mbylle / إغلاق / 閉じる

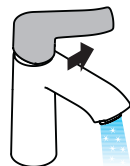

kalt / froid / cold / freddo / frío / koud / koldt / fria / zimna / studená /  
studená / 冷 / холодная / hideg / kylmä / kallt / šaltas / Hladno /  
soğuk / rece / κρύο / mrzlo / külm / auksts / hladno / kaldt / студено /  
i ftohtë / بارد / 冷たい



warm / chaud / hot / caldo / caliente / warm / varmt / quente /  
ciepła / teplá / teplá / 热 / горячая / meleg / lämmin / varmt /  
karštas / Vruća voda / sıcak / cald / ζεστό / toplo / kuum / karsts /  
topla / varm / тепло / i ngrohtë / ساخن / 温かい

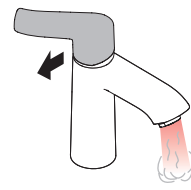
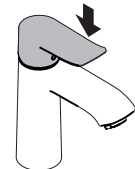

**P-IX**

**DVGW SINTEF NF**



**ETA**

<b>31080000</b>	P-IX 19412/IO	CM0347	X		X	X
<b>31082000</b>	P-IX 19412/IO	CM0347	X		X	X
<b>31084000</b>	P-IX 19412/IO	CM0347	X		X	X
<b>31088000</b>	P-IX 19413/IO	CM0347	X	X	X	
<b>31183000</b>	P-IX 19413/IO	CM0347			X	
<b>31184000</b>			X		X	X
<b>31185000</b>	P-IX 19413/IO	CM0347	X		X	
<b>31186000</b>			X		X	
<b>31280000</b>	P-IX 19417/IO	CM0347				
<b>31121000</b>			X	X	X	X
<b>31203000</b>			X			X
<b>31204000</b>			X			X
<b>31045000</b>						

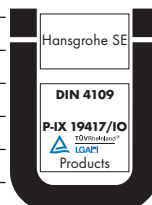
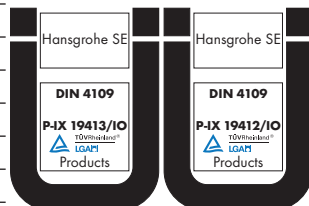



### Metris

31080000 / 31084000 / 31203000 /  
31204000 / 31045000

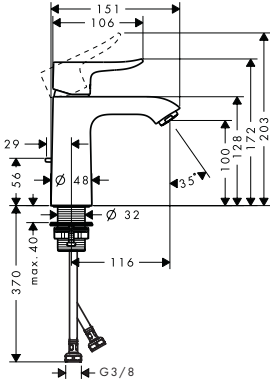

### Metris

31088000 / 31186000

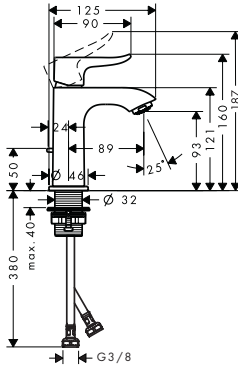

### Metris

31184000

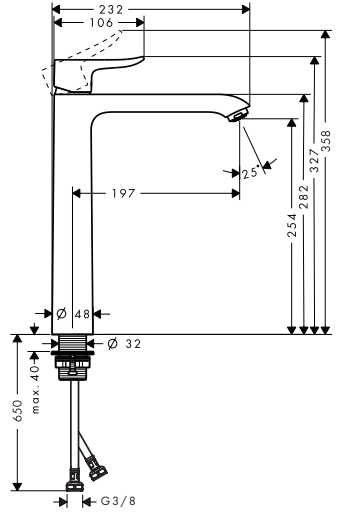

### Metris CoolStart

31121000

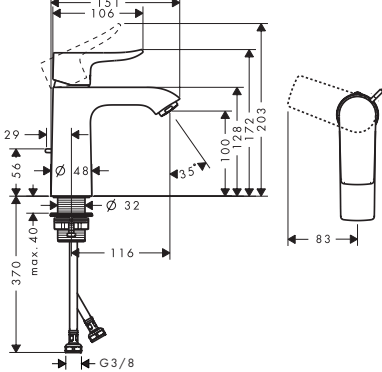

94139007

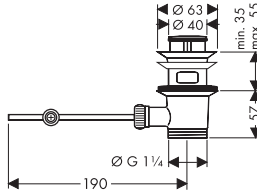

94139000

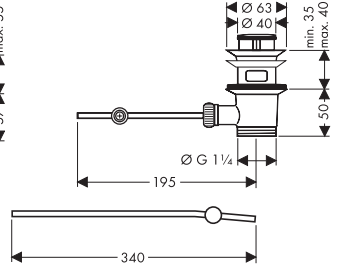

Metris 31080000 / 31082000 / 31084000 /  
31088000 / 31184000 / 31186000 / 31045000

### Metris CoolStart 31121000

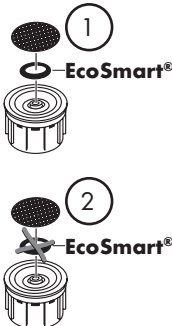
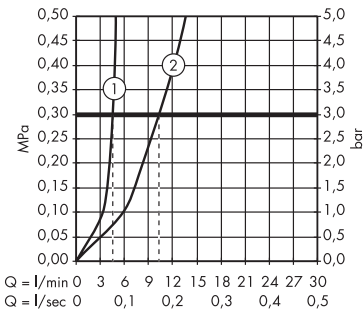

### Metris

31203000 / 31204000

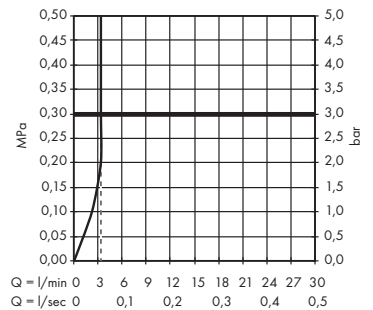



**Metris**  
31082000

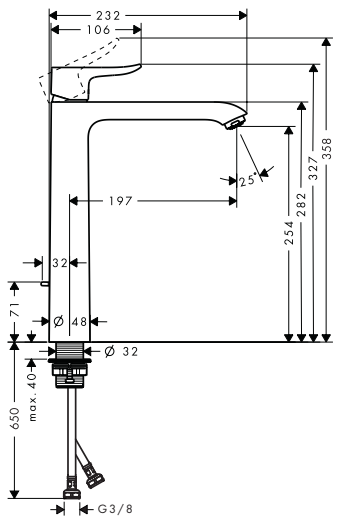

**Metris**  
31183000 / 31185000

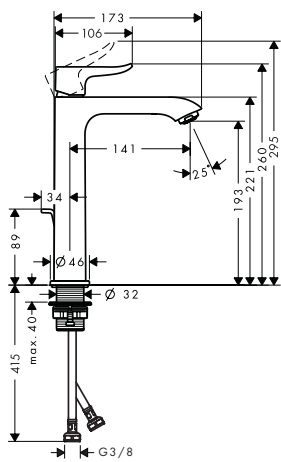

**Metris**  
31280000

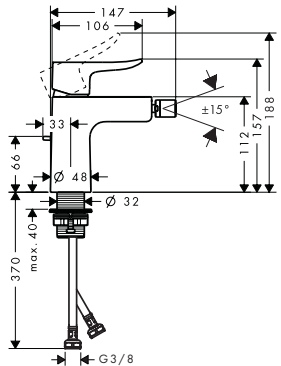

94139007

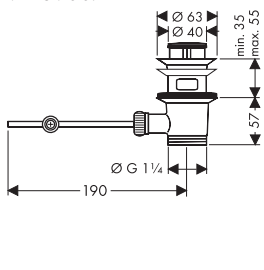

94139000

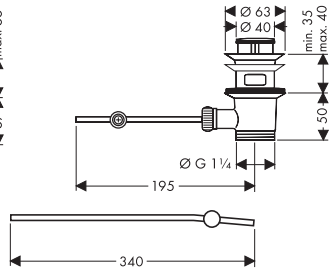

**Metris**  
31183000 / 31185000

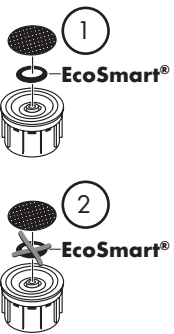
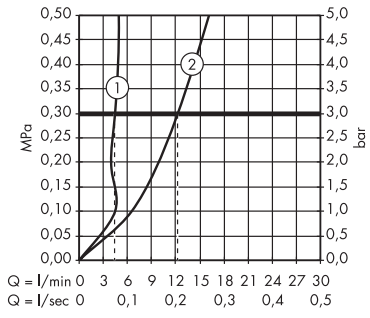

**Metris**  
31280000

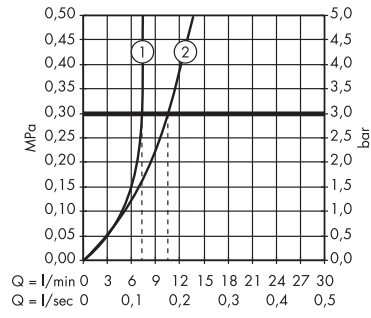



**Metris 110**

31080000 / 31084000 /  
31045000

**Metris 260**

31082000 / 31184000

**Metris**

31280000

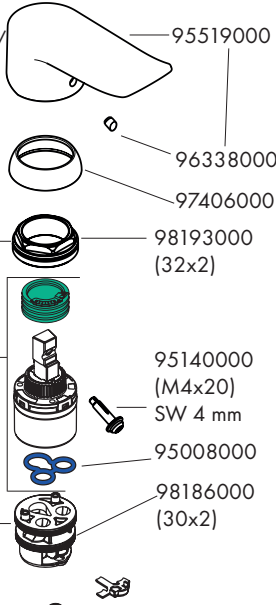

**Metris 110**

**CoolStart**  
31121000

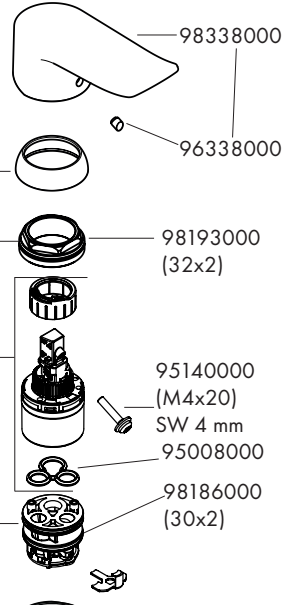

97206000  
(450 mm)  
96316000  
(900 mm)  
SW 19 mm

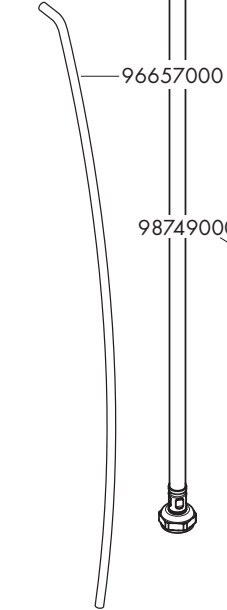

**EcoSmart®**  
13185000  
(M24x1 -  
5 l/min)  
SW 22 mm

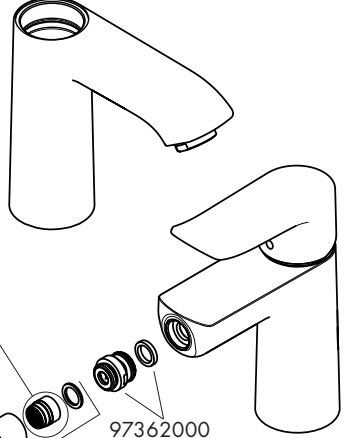

97360000  
M16x1 - 7 l/min

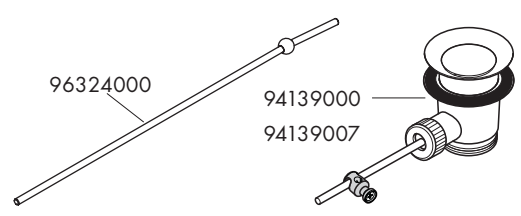



### Metris 100

31088000 / 31186000

### Metris 200

31183000 / 31185000

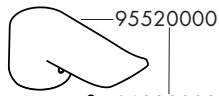

95520000

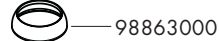

96338000

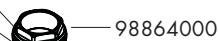

98863000



98864000

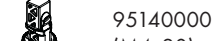

95140000



98865000



98866000

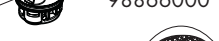

98398000



97206000



96510000

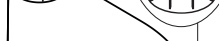

96657000

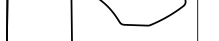

98749000

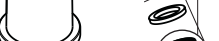

97548000



13961000



96324000



94139000

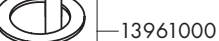

94139007



98398000



97206000



96510000

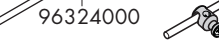

96657000



98749000

### Metris 110

31203000 / 31204000

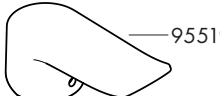

95519000



96338000



97406000



97209000



95646000



95140000



95008000



98186000



98750000



98398000

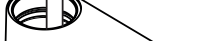

97206000

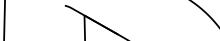

96510000



96657000



98749000



98453000



97548000

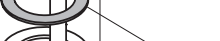

13961000



97206000



96510000



96657000

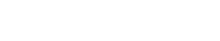

98749000

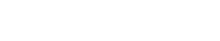

97206000

97206000

(450 mm)

96510000

(600 mm)

SW 19 mm

96657000

98749000

97548000

13961000

96324000

94139000

94139007

98398000

97206000

96510000

96657000

98749000

97548000

13961000

96324000

94139000

94139007

98398000

97206000

96510000

96657000

98749000

97548000

13961000

96324000



EcoSmart®

13185000

(M24x1 -

5 l/min)

SW 22 mm

98453000

(M24x1 -

3,5 l/min)

SW 22 mm



- DE** Reinigungsempfehlung / Garantie / Kontakt
- FR** Recommandation pour le nettoyage / Garanties / Contact
- EN** Cleaning recommendation / Warranty / Contact
- IT** Raccomandazione di pulizia / Garanzia / Contatto
- ES** Recomendaciones para la limpieza / Garantía / Contacto
- NL** Aanbevelingen inzake reiniging / Garantie / Contact
- DK** Rengøringsvejledning / Garanti / Kontakt
- PT** Recomendações de limpeza / Garantia / Contacto
- PL** Zalecenie dotyczące pielęgnacji / Gwarancja / Kontakt
- CS** Doporučení k čištění / Záruka / Kontakt
- SK** Odporúčania pre čistenie / Záruka / Kontakt
- ZH** 清洁指南 / 担保 / 接触
- RU** Рекомендации по очистке / Гарантия / Контакты
- FI** Puhdistussuositus / Takuu / Kosketus
- SV** Rengöringsrekommendationer / Garanti / Contacto
- LT** Valymo rekomendacijos / Garantija / Kontaktai
- HR** Preporuke za čišćenje / Garancija / Kontakt
- TR** Temizleme önerisi / Garanti / Temas
- RO** Recomandări pentru curățare / Garanție / Contact
- EL** Σύσταση καθαρισμού / Εγγύηση / επαφή
- SL** Priporočilo za čiščenje / Garancija / Kontakt
- ET** Puhastussuovitused / Garantii / Kontakt
- LV** Tīrīšanas ieteikumi / Garantija / Kontakti
- SR** Preporuke za čišćenje / Garancija / Kontakt
- NO** Anbefaling for rengjøring / Garanti / Kontakt
- BG** Препоръка за почистване / Гаранция / Контакт
- SQ** Këshilla rreth pastrimit / Garancia / Kontakt
- KO** 세정시 권장사항 / 품질보증 / 접촉
- AR** توصيات التنظيف / الضمان (الولايات المتحدة الأمريكية) / اتصال
- HU** Tisztítási tanácsok / Garancia / érintkezés
- JP** お手入れの方法 / 保証について / ご連絡先



[www.hansgrohe.com/  
cleaning-recommendation](http://www.hansgrohe.com/cleaning-recommendation)



[www.hansgrohe.com/  
cleaning-recommendation](http://www.hansgrohe.com/cleaning-recommendation)



[www.hansgrohe.com/  
cleaning-recommendation](http://www.hansgrohe.com/cleaning-recommendation)



[www.hansgrohe.com/  
cleaning-recommendation](http://www.hansgrohe.com/cleaning-recommendation)