

HL62.1B/1

flat-roof drain DN110 with clamping ring, heated (10-30W/230V). Walkable - 148x148mm/137x137mm



flat-roof drain DN110 vertical with insulated drain body, flange with stainless steel clamping ring (- dress the membrane over the flange and clamp it - ready!), self regulating heating element (10 - 30 W / 230 V), cut-to-size grate frame 12 - 65 mm / 148 x 148 mm and stainless steel grate 137 x 137 mm. Comes with lot cover.





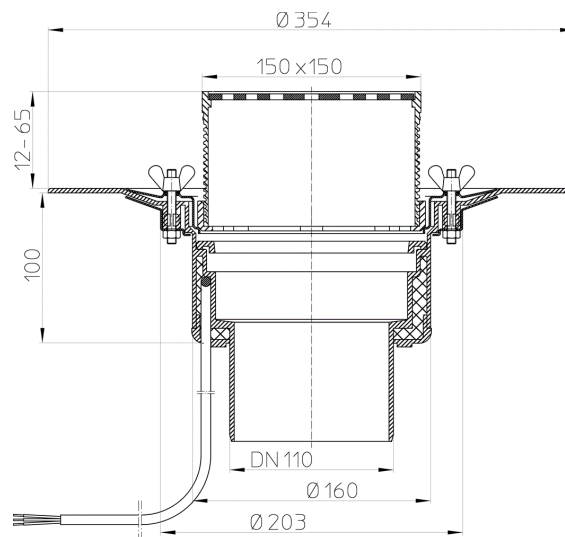





Techn. drawing











TECHNICAL DATA

material	PP	installation height	120 mm
dimension	DN110	grate frame	12-65 mm/148 x 148 mm
capacity	6,0 l/s	grate	Edelstahl 137 x 137 mm
weight	1,92	load class	K - 300 kg

MAIN DATA**spare parts**

-  **HL062.3E**
stainless steel clamping ring
-  **HL062.4E**
butterfly nuts
-  **HL062B.3E**
adapter
-  **HL062N.4E**
6 pcs. hexagon nut
-  **HL170**
flat grate d 150mm
-  **HL66.9**
grating d 145mm fluted/148x148mm/138x138mm
-  **HL0317.1E**
stainless steel grate 138x138mm
-  **HL062B.2E**
grate frame d 145mm/90mm/148x148mm
-  **HL066.4E**
O-ring 135x2,5mm

attachment

-  **HL160**
gravel guard d 150mm
-  **HL635N**
Drainage and inspection chamber for green roofs, gravel roofs and terraces. Including plastic frame and plastic grate
-  **HL0635N.2**
Galvanized steel grate for drainage and inspection chamber HL635N(.0)
-  **HL0635N.3**
Plastic cover for drainage and inspection chamber HL635N(.0)
-  **HL636N**
Extension for drainage and inspection chamber HL635N(.0)
-  **HL66**
grating d 145mm sleek/(316) stainless steel frame 150x150mm/138x138mm (316) secured
-  **HL01058D**
tailback gasket for stainless steel flange 220x155mm
-  **HL062B.3E**
adapter



HL160
gravel guard d 150mm



HL66.1
grating d 145mm sleek/(316) stainless steel frame 150x150mm/138x138mm (316) secured and slip-resistant



HL01058D
tailback gasket for stainless steel flange 220x155mm



HL062B.3E
adapter



HL160
gravel guard d 150mm



HL67
grating round d 145mm sleek/(316) stainless steel frame d 155mm/d 145mm



HL01058D
tailback gasket for stainless steel flange 220x155mm



HL062B.3E
adapter



HL160
gravel guard d 150mm

Alternatives



HL62.1/1
flat-roof drain DN110 with clamping ring, heated (10-30W/230V)



HL62.1BH/1
flat-roof drain DN110 with bitumen membrane, heated (10-30W/230V). Walkable - 148x148mm/137x137mm



HL62.1BP/1
flat-roof drain DN110 with PVC collar, heated (10-30W/230V). Walkable - 148x148mm/137x137mm

extensions



HL350
extension 130mm/d 145mm



HL350.1
extension 180mm/d 145mm with flange and waterproofing kit HL84



HL350.1H
extension 180mm/d 145mm with bitumen membrane



HL65
extension 300mm/d 125mm with clamping ring



HL65H
extension 300mm/d 125mm with bitumen membrane



HL65P
extension 345mm/d 125mm with PVC collar

Waterproofing Kits

**HL84.CU**

waterproofing kit with copper sheet d 500mm

**HL84.E**

waterproofing kit with zincplated steel sheet d 500mm

**HL84.H**

waterproofing kit with bitumen membrane d 500mm

DOWNLOADS

Foto Print	HL62x1B_pr.tif	max.
Foto Web	HL62x1B_B.jpg	640x480/300dpi
Foto Parts List	HL62x1B_gr.jpg	150x150/72dpi
Techn. drawing	HL62_1B_1_a.pdf	pdf
CAD	HL62_1B_1_2_a.dxf	dxf
example of use	HL62_1B_1_PZ.pdf	pdf