

# SNB SERIES

Standing Network Rack 24U, 37U, 42U and 47U Sizes

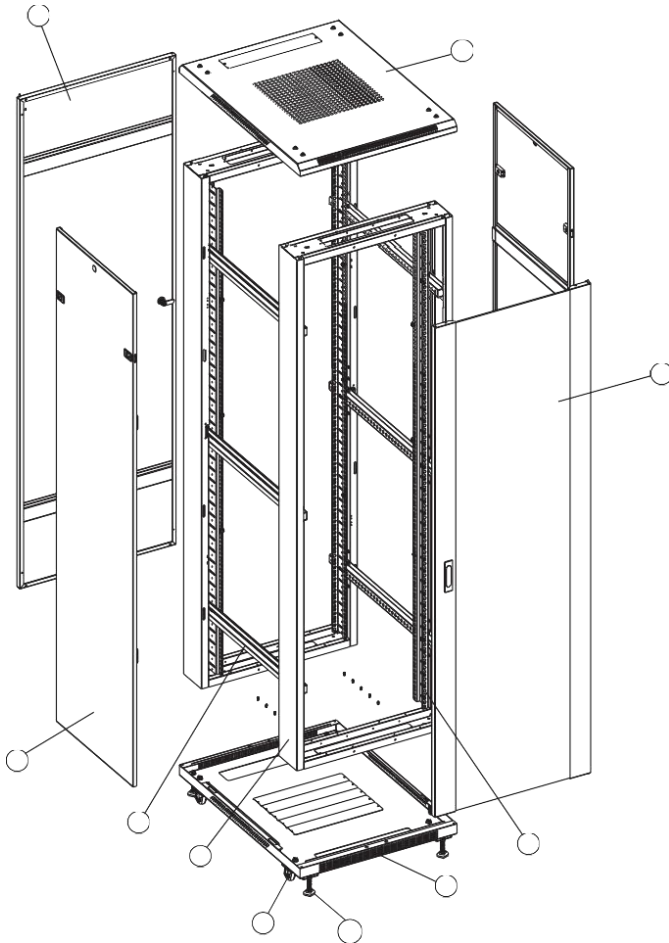

## Components of SNB(600mm Width) Series Standing Network Rack



S/N	Name	Quantity
1	Top cover	1
2	Bottom panel	1
3	Door frame	2
4	Front door	1
5	Rear door	1
6	Side panel	2
7	Horizontal beam	6
8	Vertical rail	4
9	Castor(2 with brake)	4
10	Levelling feet	4

<b>Note</b>	≤32U with 4 horizontal beams.	>32U with 6 horizontal beams.
	Side panel with small round lock.	

## ■ Main Dimension

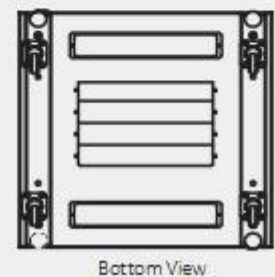
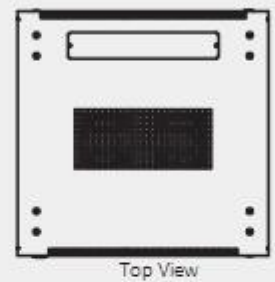
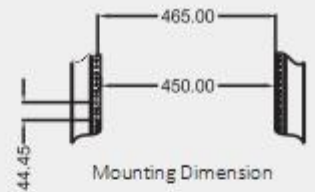
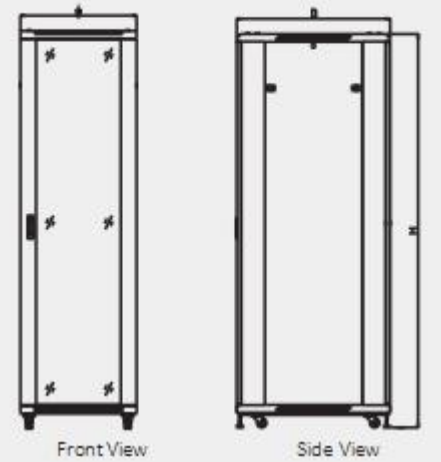

## Components of SNB(800mm Width) Series Standing Network Rack

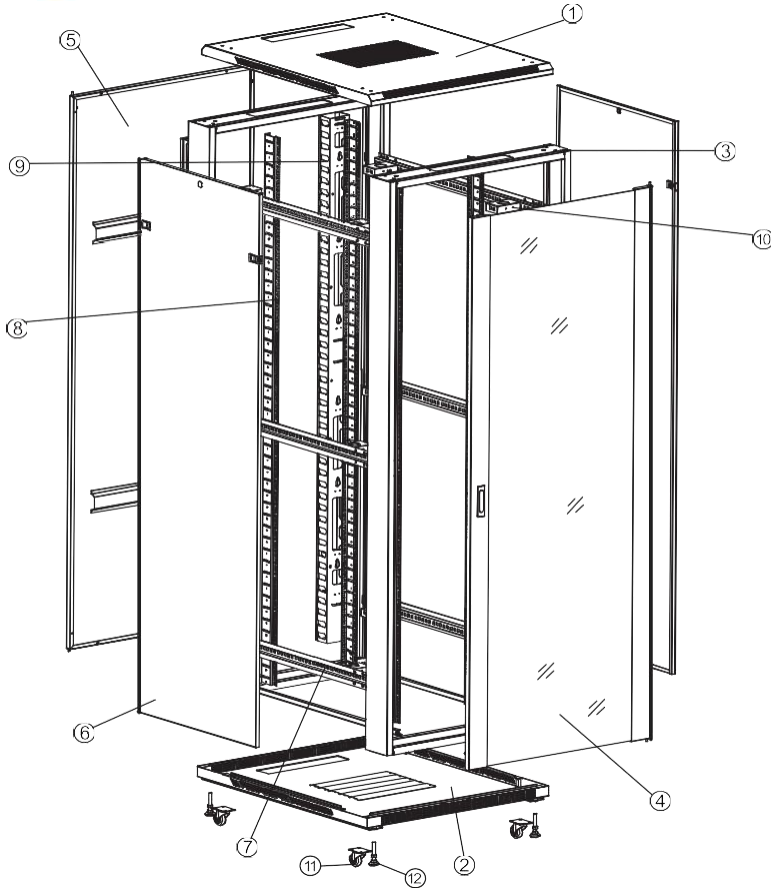

S/N	Name	Quantity
1	Top cover	1
2	Bottom plate	1
3	Door frame	2
4	Front door	1
5	Rear door	1
6	Side panel	2
7	Horizontal beam	6
8	Vertical rail	4
9	Cable management rail	2
10	Connecting box	12
11	Castor (2 with brake)	4
12	Levelling feet	4

<b>Note</b>	≤32U with 4 horizontal beams, >32U with 6 horizontal beams.
	≤32U with 8 connecting boxes, >32U with 12 connecting boxes.
	Vertical cable management included for 800mm wide SNB network rack.

## ■Main Dimension

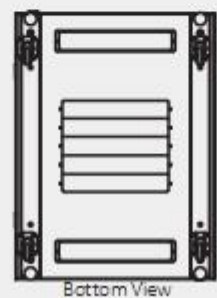
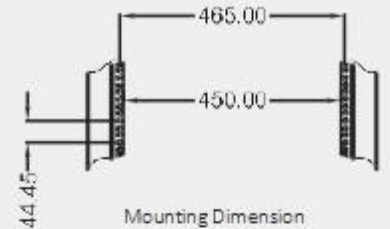
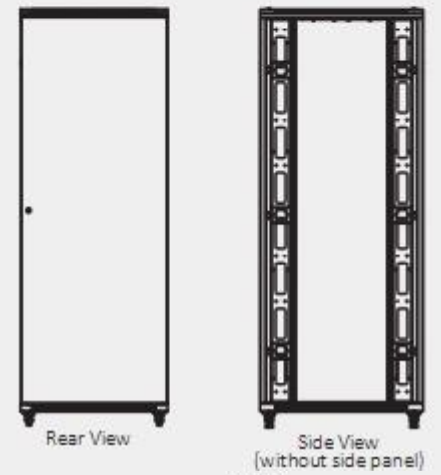

## ■ Specifications

Model	Capacity (U)	Dimension W*D*H(mm)	KD Packing Dimension			
			Carton A W*D*H(mm)	Carton B W*D*H(mm)	Carton C W*D*H(mm)	Volume (CBM)
SNB6622	22	600*600*1166	1095*620*320	620*620*130	/	0.27
SNB6627	27	600*600*1388	1320*620*320	620*620*130	/	0.31
SNB6632	32	600*600*1610	1540*620*320	620*820*130	/	0.36
SNB6642	42	600*600*2055	1980*620*320	620*620*130	/	0.44
SNB8842	42	800*800*2055	1980*820*320	820*820*130	/	0.61
SNB6142	42	600*1000*2055	1980*620*320	1020*620*130	1910*60*730	0.56
SNB8142	42	800*1000*2055	1980*820*320	1020*820*130	/	0.63
SNB6842	42	600*800*2055	1980*620*320	820*620*130	/	0.46
SNB6942	42	600*900*2055	1980*620*320	620*920*130	1910*60*730	0.55

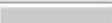
<b>Note</b>	Different kinds of doors are optional.	Ornament strip is optional.
	Hardware: ≤27U: 20 sets cage nuts; >27U, ≤37U: 30 sets cage nuts; >37U, ≤47U: 40 sets cage nuts.	
<b>Color</b>	RAL9005 	RAL7035 
<b>Material</b>	SPCC Cold Rolled Steel.	

## Optional Doors



A. Tempered glass door, with vented strips.  
Lock: Spring Lock



B. Tempered glass door, with vented holes  
Lock: Spring Lock



C. Tempered glass door  
Lock: Advanced Lock



D. Solid iron door  
Lock: Small Round Lock



E. Arc and curved door  
Lock: Spring Lock



F. Hexagonal vented curved door  
Lock: Spring Lock



G. Round vented arc door  
Lock: Spring Lock



H. Round vented door  
Lock: Small round Lock



I. Round vented door  
Lock: Advanced Lock



J. Hexagonal vented door  
Lock: Moon Light Lock



K. Split vented rear door  
Lock: Moon Light Lock



L. Tempered glass door  
Lock: Advanced Lock

