

SELEKTA 170 top3

1700130

SELEKTA 174 top3

1740130

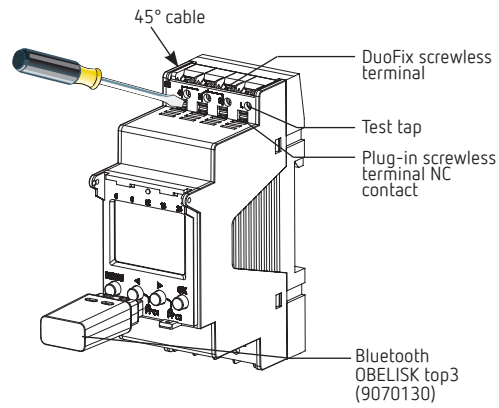

## 1. Basic safety information

**WARNING**  
**Danger of death from electric shock or fire!**  
 ▶ Installation should only be carried out by a qualified electrician!

- The device is designed for installation on DIN top hat rails (in accordance with EN 60715)
- Power reserve (10 years) is reduced if memory card is inserted (using battery power)
- Corresponds to type 1 STU nach IEC/EN 60730-2-7

## 2. Proper use

- The astronomic time switch is used, for instance, for lighting equipment (roads, external staircases, display windows, entrances etc.)
- Only for use in closed, dry rooms

**!** Do not use on safety devices, e.g. escape route doors, fire safety equipment etc.

### Disposal

- ▶ Dispose of device in environmentally sound manner

## 3. Installation and connection

**WARNING**  
**Danger of death from electric shock or fire!**  
 ▶ Installation should only be carried out by a qualified electrician!

### Time switch installation

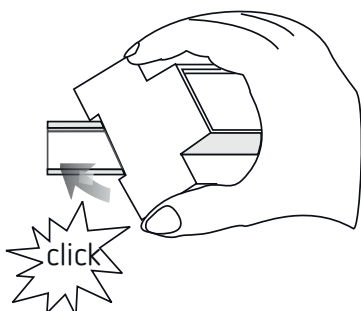

**!** Check the depth of the control cabinet when OBELISK top3 is connected. The depth must be > 94 mm.

- ▶ Install on DIN top hat rails (in accordance with EN 60715)
- ▶ Disconnect power source
- ▶ Cover or shield any adjacent live components
- ▶ Ensure device cannot be switched on
- ▶ Check absence of voltage
- ▶ Earth and bypass

### Connecting the cable



SELEKTA 170 top3

SELEKTA 174 top3

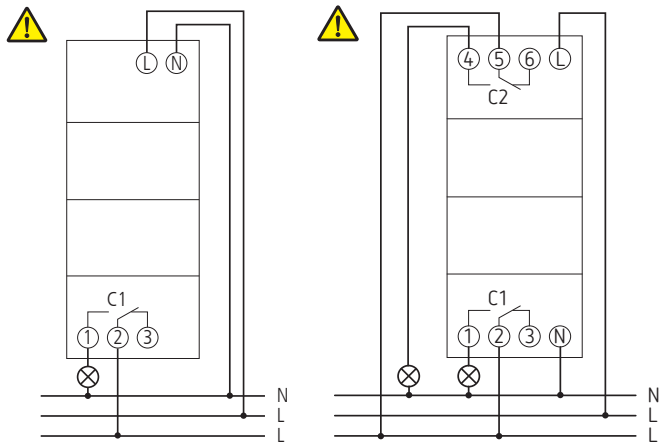

- ▶ Correct connection required for smooth zero-cross switching operation
- ▶ Strip cable to 8 mm (max. 9)
- ▶ Insert cable in the open DuoFix plug-in terminal at 45° (2 cables per terminal position possible)
- ▶ To open the DuoFix plug-in terminal, press screwdriver downwards

### Disconnecting the cable

- ▶ Use the screwdriver to push the load line connection opener downwards

# 4. Device description

## Display & buttons

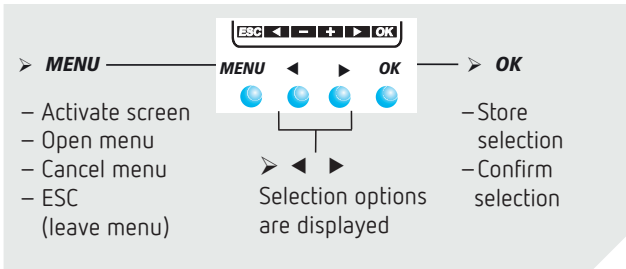
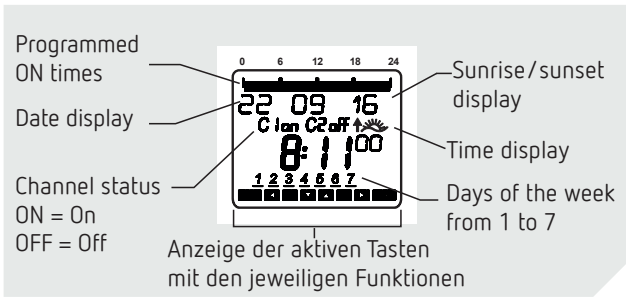

## Operating instructions

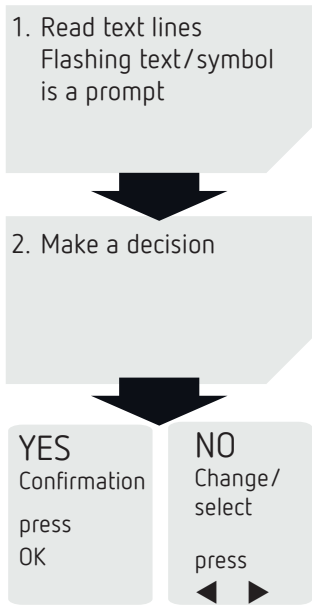

## Overview of menu selection

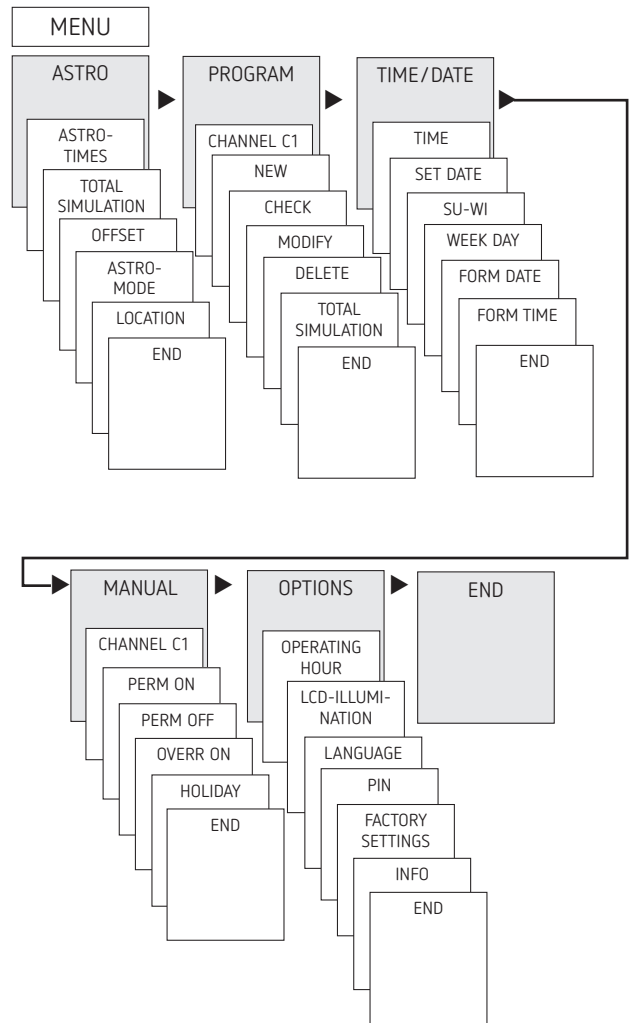

## Initial start-up

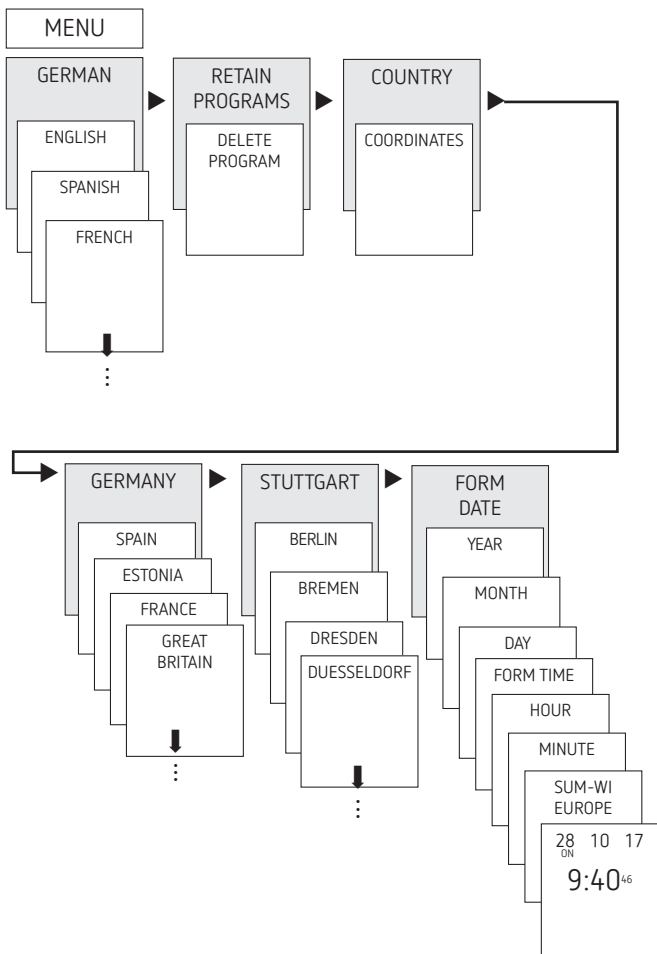

- Set language, country, town/city, date, time as well as summer/winter time (SO-WI)
- Press any button and follow on-screen instructions (see figure)

## 5. Settings and functions

### ASTRO menu

In the ASTRO menu astro times, complete simulation, offset, astromode as well as position (location) can be viewed or changed.

- Astro times  
Display of the astro times (including the offsets) for the current day
- Total simulation  
Display of the switching behaviour with a freely selectable Start date (the holiday program is not displayed)
- Offset  
The offset (adjustment value) can be used to shift calculated astro times  $\pm 120$  min. This enables the Astro switch-on and switch-off times to be adapted to local circumstances (e.g. mountains, high buildings etc.) or to personal requirements.

- Astro mode
  - Evenings on, mornings off Switches: on at sunset, switches off at sunset (Example: street lighting)
  - Evenings off, mornings on Switches off: at sunset, switches on at sunrise (Example: terrarium).
  - Astro inactive: The astro times are ineffective (timer function only).
- Position
  - Location set by selecting a city or by coordinates (latitude/longitude, time zone). The Bluetooth OBE-LISK top3 allows up to 10 further cities (= favourites) to be entered.

### Change astro time / position

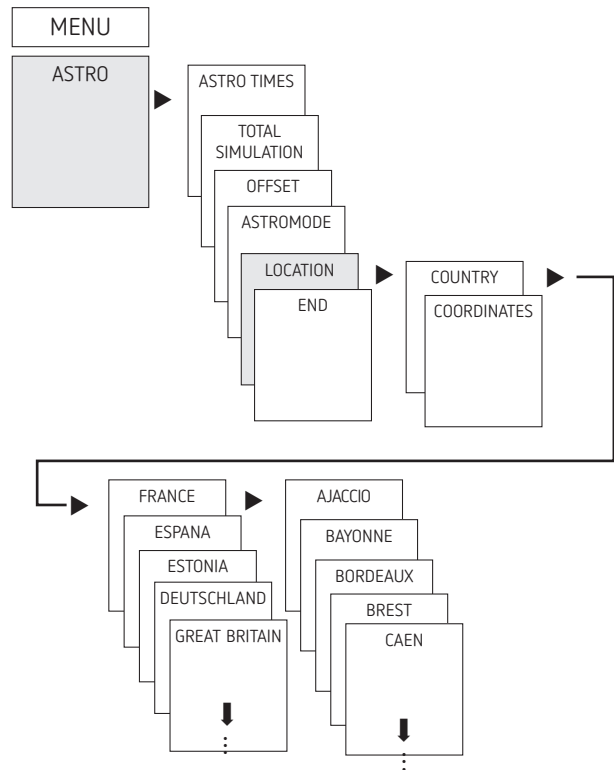

- E.g. enter a different country, a different town/city
- Press MENU (see picture).

## Setting the offset function

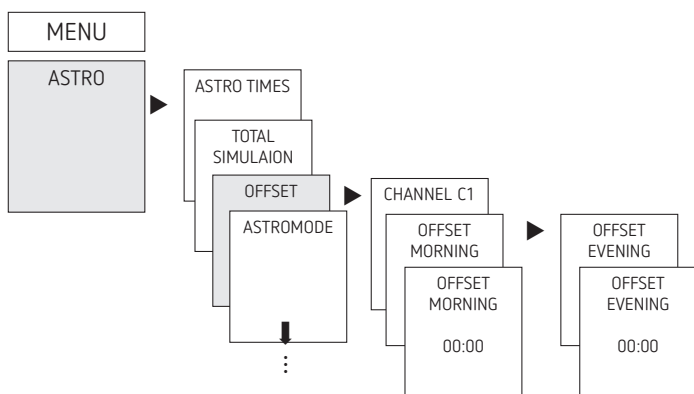

- Press MENU
- Select ASTRO and press OK to confirm
- Select OFFSET and press OK to confirm
- Select CHANNEL and press OK to confirm
- Select OFFSET MORNING or OFFSET EVENING and press OK to confirm
- Set the time and press OK to confirm

## Setting summer/winter time

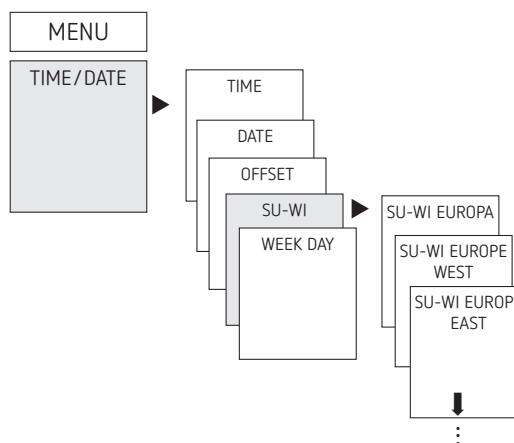

- Press MENU
- Select TIME/DAT and press OK to confirm
- Select SO-WI and press OK to confirm
- Select region for the SO-WI time and press OK to confirm

## Set fixed switching time

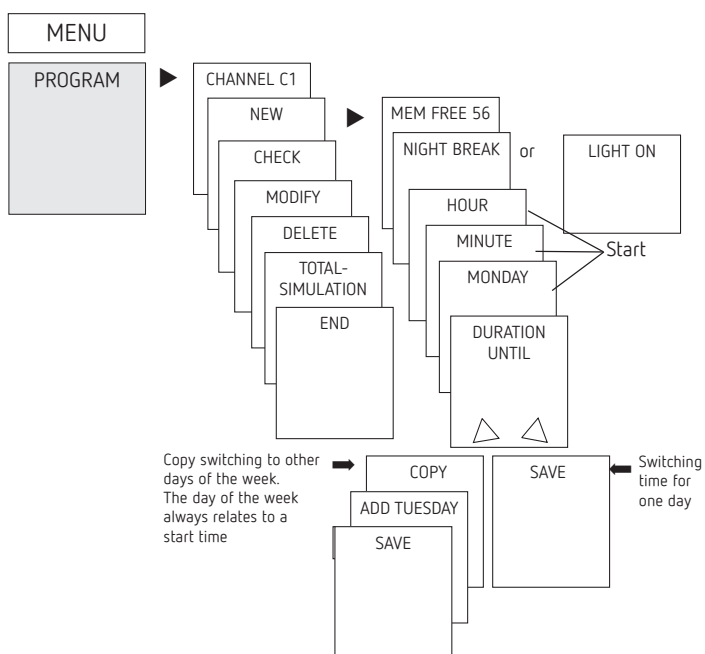

## Switch Permanent ON / OFF

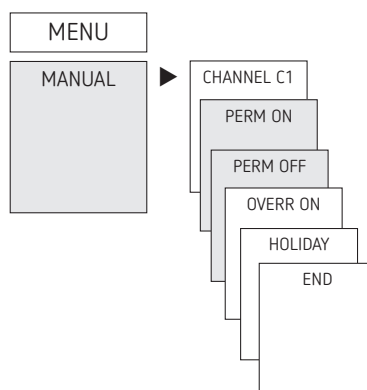

- Press MENU
- Select MANUAL and press OK to confirm
- Select CHANNEL and press OK to confirm
- Select PERMANENT ON or PERMANENT OFF and press OK to confirm

① A switching time always consists of a start time and an end time (LASTS UNTIL). e.g. night switch-off on Monday 23:00 – 05:00 hrs

① There are 56 memory cells available

- Press MENU
- Select PROGRAM and press OK to confirm
- Select CHANNEL and press OK to confirm
- Select NEW and press OK to confirm
- Select NIGHT SWITCH OFF or DAY SWITCH ON and press OK to confirm
- Set selected switching times (hours, minutes, day) and press OK to confirm
- Select COPY or SAVE
- To save press ► and press OK to confirm
- To copy press OK

## Setting holiday function

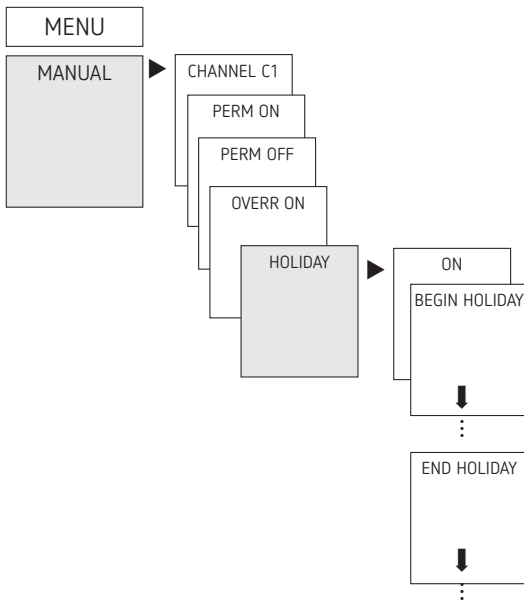

- Press MENU
- Select MANUAL and press OK to confirm
- Select CHANNEL and press OK to confirm
- Select HOLIDAY and press OK to confirm
- Select ON and press OK to confirm
- Select START HOLIDAY and press OK to confirm
- Enter YEAR, MONTH, DAY, HOUR and press OK to confirm
- Select END HOLIDAY and press OK to confirm
- Enter YEAR, MONTH, DAY, HOUR and press OK to confirm

## Activate PIN-Code

The PIN code is set in OPTIONS via the menu.

- ① If you have lost the PIN, please call the Theben Hotline.
- ① Have the serial number ready!

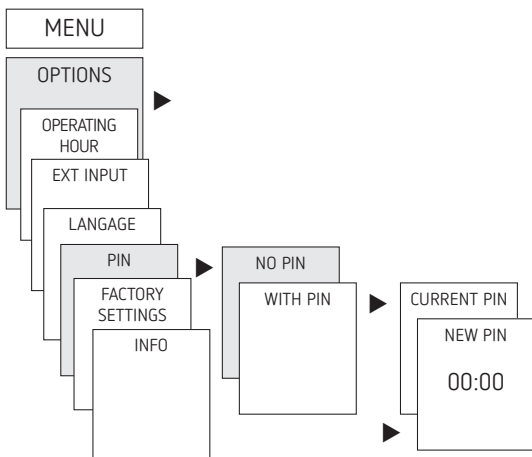

## Setting manual or permanent switching

Manual and permanent switching can be set using the menu in MANUAL or (in the automatic screen) by key combination (see fig).

- Manual control  
Reversing the channel status to the next automatic or programmed switching.

- Permanent switching  
As long as a permanent switching (on or off) is activated, the programmed switching times are ineffective.

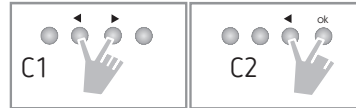

### Activate manual switching

- Briefly press both keys simultaneously

### Activate permanent switching

- Simultaneously press both keys for 2 seconds

### Cancelling manual/permanent switching

- Press both keys simultaneously

## Operating hour counter

The operating hours of the channel (relay) are displayed and deleted in the OPTIONS menu. If the number of operating hours exceeds the value set in the Service menu, SERVICE will appear in the display.

Example: Replace a lamp after 5,000 h.

- Delete operating hours or set a higher value in Service (e.g. to 10,000 h)

## Using Bluetooth OBELISK top3

All functions can also be transferred to the time switch using the Bluetooth OBELISK top3 memory card (9070130).

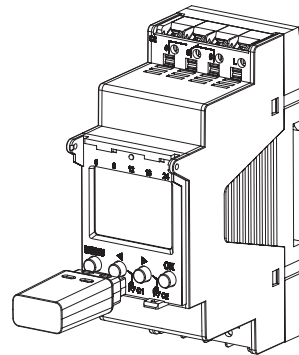

### Copy OBELISK → Time switch

Copies all switching programs and settings from the time switch to the memory card. Starting OBELISK program

### Copy Time switch → OBELISK

Copies all switching programs and settings from the time switch to the memory card.

### Start OBELISK program

Takes on the switching times that are programmed on the memory card.

As soon as the memory card is removed, the switching times of the time switch are re-activated.

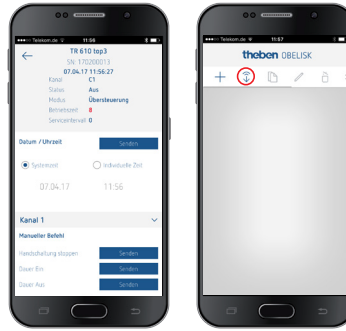
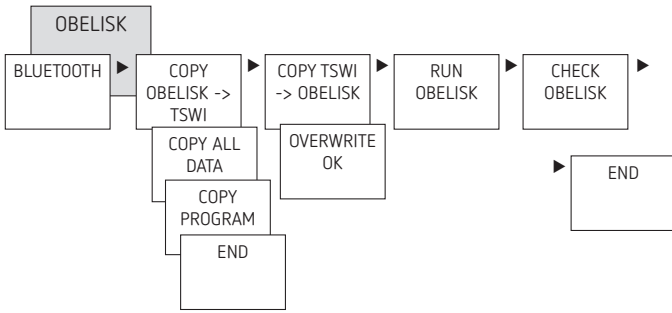



## Connect time switch, Bluetooth OBELISK top3 and smartphone (via app)

The devices in the top3 range can be programmed using an app (for Android, iOS) on a mobile end device. Communication takes place via Bluetooth OBELISK top3. Switch programmes are transferred and direct switch commands are sent to the device.

- Download the OBELISK top3 app from the App Store or Google Play Store



ⓘ Bluetooth connection only possible in automatic mode, not in manual mode like OPTIONS etc.

- Open the app and activate using one of the 3 commands, by pressing „Download“ , „Manual command“  or „Upload“ 
- Device/device list appears on the display.

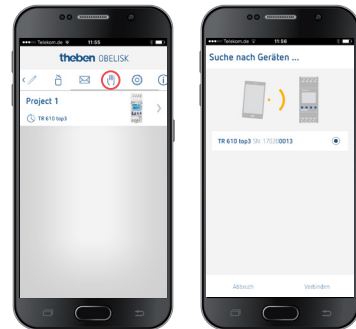

- Press „Connect“



- Press OK on the time switch  
→ The display shows BLUETOOTH ACTIVE
- Press „Close“ in the app within 30 s

Now, for example, projects can be created and uploaded.

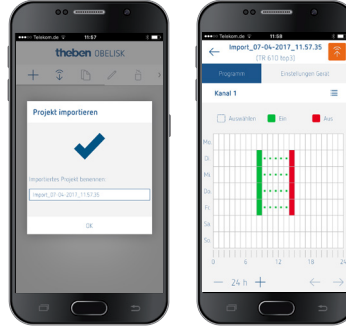

## Resetting the time switch

- Press the 4 buttons simultaneously.  
→ You can choose between RETAIN PROGRAM and DELETE PROGRAM.

## 6. Technical Data

|   |   |
|---|---|
| Operating voltage:  | 230 V AC +10 % / - 15 %   |
| Frequency:  | 50–60 Hz  |
| Standby:  | 0,4 W   |
| Max switching capacity:   | 16 A (at 250 V AC, $\cos \varphi = 1$ )                             |
| Switching capacity:   | 10 A (at 250 V AC, $\cos \varphi = 0,6$ )                           |
| Min. switching capacity:  | 10 mA/230 V AC<br>100 mA/24 V AC/DC                                 |
| Switch output:  | switching of any phase is permitted (SELEKTA 174 top3)              |
| SELEKTA 170 top3:   | suitable for switching SELV (Safe Extra-Low Voltage)                |
| Protection rating:  | IP 20 in accordance with EN 60529                                   |
| Protection class:   | II in accordance with EN 60730-1 subject to designated installation |
| Operating temperature:  | -30 °C ... +55 °C   |
| Power reserve:  | 10 years at +20 °C (without Bluetooth OBELISK top3)                 |
| Switching accuracy:   | accurate to the second  |
| Time accuracy (typical)   | $\pm 0,25$ s/day (25 °C)  |
| Rated impulse voltage   | 4 kV  |
| Pollution degree  | 2   |
| Contact   | two way switch, contact $\mu$                                       |
| Max. switching cycles with 16 A resistive load  | 50 000  |
| Incandescent lamp load  | 2600 W  |
| Halogen lamp load   | 2600 W  |
| Fluorescent lamps (LLB low-loss ballasts):<br>uncorrected<br>series-corrected<br>parallel-corrected | 2600 VA<br>2600 VA<br>1300 VA (130 $\mu$ F)                         |
| Compact fluorescent lamps (EB)  | 1100 W  |
| LED-lamps (< 2 W)   | 50 W  |
| LED-lamps (> 2 W)   | 600 W   |
| Bluetooth OBELISK top3:<br>– Protection rating:<br>– Temperature:<br>– Range:                       | IP 40<br>-30 °C to +55 °C<br>15 m on open air test site             |

① The time switch display is only fully functional at temperatures from +5 °C - +55 °C.

## 7. Contact

### Theben AG

Hohenbergstr. 32  
72401 Haigerloch  
GERMANY  
Tel. +49 7474 692-0  
Fax +49 7474 692-150

### Hotline

Tel. +49 7474 692-369  
hotline@theben.de

Addresses, telephone numbers etc.  
[www.theben.de](http://www.theben.de)